



GET CONTROL. GET HONEYWELL.

Application Selection and Cross-Reference Guide

The Innovative Leader

For more than a century, Honeywell has been on the leading edge of product development for energy-efficient HVAC and building automation products. Contractors and building owners count on Honeywell commercial thermostats for the latest technology, ease-of-use and energy savings.

Support

[Commercial Thermostats Hotline](#)

1-763-954-6464

[Web Site](#)

customer.honeywell.com

[New Product Information](#)

customer.honeywell.com/buildings

[Contractor PRO™ Program](#)

www.contractorpro.com

[Technical and Sales Literature](#)

customer.honeywell.com

For more information, please contact your local Honeywell authorized distributor or Honeywell sales representative.





WebStat® Controller

Web Accessible Thermostats

- Honeywell's WebStat® system is composed of the world-class T7350H LONWORKS® communicating thermostats combined with a single WebStat controller which enables your network of T7350H thermostats to be configured and monitored from any computer with internet access from anywhere in the world.

Features

- Configure/commission/monitor through the same easy-to-use Web-based interface
- Free job estimating and submittal tools that provide everything from wiring diagrams to guide specs
- Data trending for use in troubleshooting
- Customizable floor plan layouts

OS Number	Description	Application
W7350A1000	WebStat® Controller with LONWORKS® Loncard and Power Supply	Web-Based Network Controller
T7350H1009	Communicating Commercial Programmable Thermostat	T7350H1009: 3 Heat/3 Cool or 2 Heat/4 Cool Conventional or 3 Heat/2 Cool Heat Pump
T7350H1017		T7350H1017: Two 4-20 mA Outputs for Modulating Applications

WebStat® Features and Benefits Summary				
	Low Installed Cost	Low Operating & Service Cost	Ease of Use	Advanced Comfort
Embedded Software	•		•	
Integrated Graphic, Config and Commissioning Tool	•	•	•	
Wizard Programming Tool	•	•	•	
Device Self Discovery	•			
Field Wiring & Sensor Avg. Diagrams	•	•		
Thin Client Web Remote Monitoring	•	•	•	•
Trending, Troubleshooting		•		•
Floor Plan Locator		•		
Remote Programming	•	•	•	•
Multi-User Access View			•	•
User Privilege Setup		•	•	•
Advanced Dehumidification				•
Special Event, Holiday Scheduling				• (E)
Override Controls				• (E)
Thermostat Assignment				• (E)
Advanced Remote Sensing				•

E=Energy Savings



T7350H

Communicating Thermostat

- Communication via LONWORKS® Network
 - Remote access for diagnostics
- Integrated humidity sensor
 - Several strategies for dehumidifying
- 365-Day Schedule
 - Schedule holidays throughout the year to save energy
- Remote sensing
 - Indoor, outdoor, humidity, occupancy and discharge air sensors available for added flexibility
 - Outdoor Air and Discharge Air Temperature Lockout
- Controls up to 3H/3C or 2H/4C conventional systems or 3H/2C heat pumps (T7350H1009)
 - Flexibility allows the same thermostat to be used on every RTU in the system
- Has two 4-20 modulating outputs for controlling heating and cooling valves (T7350H1017)
 - Allows thermostat to be used in hydronic heating or cooling applications
 - Control of staged and modulating hybrid systems

Compatible With These Honeywell Systems	
LCBS LonSpec™/LonStation™	XL15B W7760B2001
WEBS ^{AX} ™ T7350 Wizard	WebStat® W7350A1000

OS Number	Description	Application
T7350H1009	Communicating Commercial Programmable Thermostat	T735H1009: 3 Heat/3 Cool or 2 Heat/4 Cool Conventional or 3 Heat/2 Cool Heat Pump
T7350H1017		T7350H1017: Two 4-20 mA Outputs for Modulating Applications

Replacements							Sensor Capabilities
		Honeywell	White-Rodgers	Invensys/ Robertshaw	Carrier/Totaline	TCS/Basys Controls	
Communicating	T7350H1009	All T7300s with Q7300H Subbases	No Equivalent Offering	No Equivalent Offering	No Equivalent Offering	SZ1022, SZ1024, SZ1031, SZ1033, SZ1035, SZ1009	T7771A1005, TR21, TR21-A (averaging), TR22, TR23, TR24,
	T7350H1017	No Previous Offering	No Equivalent Offering	No Equivalent Offering	No Equivalent Offering	SZ1017a, SZ1053	C7772A1012 (flush mount), C7770A1006 (return airduct), C7041P2004 (button sensor)



T7350M

Modulating and Staged Thermostat

- Integrated humidity sensor
 - Several strategies for dehumidifying
- 365-Day Schedule
 - Schedule holidays throughout the year to save energy
- Remote sensing
 - Indoor, outdoor, humidity, occupancy and discharge air sensors available for added flexibility
 - Outdoor Air and Discharge Air Temperature Lockout.
- Has two 4-20 modulating outputs for controlling heating and cooling valves
 - Allows thermostat to be used in hydronic heating or cooling applications
- Control of staged and modulating hybrid systems
- PID loop
 - First thermostat with configurable PID loop

OS Number	Description	Application
T7350M1008	Modulating Commercial Programmable Thermostat	<ul style="list-style-type: none"> – Two 4-20 mA Outputs for Modulating Applications – Two Relays for Staged Control – Advanced Dehumidification

Replacements							Sensor Compatibility
		Honeywell	White-Rodgers	Invensys/ Robertshaw	Carrier/Totaline	TBS/Basys Controls	
Modulating	T7350M1008	No Previous Offering	No Equivalent Offering	No Equivalent Offering	No Equivalent Offering	SZ1017a, SZ1053	T7771A1005, TR21, TR21-A (averaging), TR22, TR23, TR24, C7772A1012 (flush mount), C7770A1006 (return airduct), C7041P2004 (button sensor)



T7350A, B, D Standalone Staged Thermostat

- Integrated humidity sensor (T7350D)
 - Several strategies for dehumidifying
- 365-Day Schedule
 - Schedule holidays throughout the year to save energy
- Remote sensing (T7350B, D)
 - Indoor, outdoor, humidity, occupancy and discharge air sensors available for added flexibility
 - Outdoor Air and Discharge Air Temperature Lockout
- Controls conventional or heat pump systems
- Flexibility allows the same thermostat to be used on every top roof unit in the system
- PID loop
 - First thermostat with configurable PID loop

OS Number	Description	Application
T7350A1004	T7350 Commercial Programmable Thermostat	T7350A1004: 1 Heat/2 Cool and 2 Heat/1 Cool Conventional, 2 Heat/1 Cool Heat Pump
T7350B1002		T7350B1002: 3 Heat/2 Cool and 2 Heat/3 Cool Conventional, 3 Heat/2 Cool Heat Pump
T7350D1008		T7350D1008: 3 Heat/3 Cool and 2 Heat/4 Cool Conventional, or 3 Heat/2 Cool Heat Pump with 2 Auxiliary Stages, Advanced Dehumidification and Occupancy Option

Replacements							Sensor Compatibility
		Honeywell	White-Rodgers	Invensys/ Robertshaw	Carrier/ Totaline	TCS/basys Controls	
Conventional/Heat Pump	T7350A1004	All T7300s with Q7300A2008 Subbase	1-F90-371, 1-F97-371, 1-F96-344, 1-F90-374, 1-F97-374	9700i, 9701i		SZ1009	
	T7350B1002	All T7300s with Q7300A and Q3700C Subbases	All White-Rodgers Thermostats	9700i Series, 300 Series	All Carrier/Totaline Thermostats	Sz1022, SZ1024, SZ1031, SZ1033, SZ1009	T7771A1005, TR21, TR21-A (averaging), TR22, TR23, TR24, C7772A1012 (flush mount), C7770A1006 (return airduct), C7041P2004 (button sensor)
	T7350D1008	All T7300s with Non-Q7300H Subbases	All White-Rodgers Thermostats	All Invensys/Robertshaw Thermostats	All Carrier/Totaline Thermostats	SZ1022, SZ1024, SZ1031, SZ1033, SZ1035, SZ1009	



T7351F

Standalone Staged Thermostat

- Keypad programming
 - All configuration is done through the keypad
- Integrated humidity sensor
 - Several strategies for dehumidifying
- 365-Day Schedule
 - Schedule holidays throughout the year to save energy
- Remote sensing
 - Indoor, outdoor, humidity, occupancy and discharge air sensors available for added flexibility
 - Outdoor Air and Discharge Air Temperature Lockout
- Controls conventional or heat pump systems
- Flexibility allows the same thermostat to be used on every top roof unit in the system

OS Number	Description	Application
T7351F2010	T7351 Commercial Programmable Thermostat	3 Heat/3 Cool and 2 Heat/4 Cool Conventional, or 3 Heat/2 Cool Heat Pump with 2 Auxiliary Stages, Advanced Dehumidification and Occupancy Option

Replacements						Sensor Compatibility	
		Honeywell	White-Rodgers	Invensys/ Robertshaw	Carrier/Totaline	TCS/ibasys Controls	
Conventional/Heat Pump	T7351F2010	All T7300s with Non-Q7300H Subbases	All White-Rodgers Thermostats	All Invensys/Robertshaw Thermostats	All Carrier/Totaline Thermostats	SZ1022, SZ1024, SZ1031, SZ1033, SZ1035, SZ1009	T7771A1005, TR21, TR21-A (averaging), TR22, TR23, TR24, C7772A1012 (flush mount), C7770A1006 (return airduct), C7041P2004 (button sensor)

T7350/T7351F Applications



Schools

- Up to 10 holidays can be scheduled into the Holiday Scheduler, which can be programmed to handle multiple days per holiday event, can program closed days during the summer or spring break and can be programmed for specific calendar events. (All Models)
- Dehumidification features can be used to control dew points in buildings and can be deployed where moisture is an issue, such as around school pools or in humid locations. (T7350D, M, H and T7351F)
- Temporary Override can be configured from 1 to 8 hours to allow override from unoccupied schedule to an occupied schedule as well as for classrooms that are only used for parts of the week or just occasionally used. (All Models)
- PID Algorithm is the best control algorithm available that can heat and cool large spaces, such as gymnasiums or auditoriums, quickly and accurately. The PID Algorithm is specifically tuned for oversized equipment and has a short sensor time constant that can react quickly to demand changes. (All T7350 Models)



Banks

- Easy-to-use Holiday Scheduler. (T7350B, D, M, H and T7351F)
- T7350 Palm® Software comes pre-configured with all bank holidays for easy programming into the thermostat. (All T7350 Models)



Healthcare and Gym Facilities

- Solid solution for rooftop units on facilities that demand very accurate temperature and enthalpy control. The PID Algorithm will maintain the most accurate temperature control in the facility. (All T7350 Models)
- Dehumidification features are ideal for controlling high-moisture areas. (T7350D, M, H and T7351F)



Restaurant/Food Service

- PID Commercial Algorithm provides the best comfort control to react to the constantly changing food service and restaurant environments, reacting quickly to changing load demands via fast-sensing time constants. (All T7350 Models)
- Remote Sensing configuration options allow the use of commercial 20K ohm and 10K ohm sensors to create a 20K ohm averaging network, a good solution for food service locations that have high load demands. (T7350B, D, M, H and T7351F)
- Economizer function allows restaurants to meet ventilation requirements and is also important to balance the air intake of the restaurant. Restaurants that are not properly balanced do not achieve good comfort control as they draw in unconditioned air. (All Models)



Churches/Public Worship

- PID Algorithm is the best control algorithm available that can heat and cool large spaces, such as sanctuaries and fellowship rooms, quickly and accurately. The PID Algorithm is specifically tuned for oversized equipment and has a short sensor time constant that can react quickly to demand changes. (All T7350 Models)
- T7350 Wall Modules, including the T7771, TR22, TR23 and TR24 models allow for setpoint-only adjustment with range stops, temporary override control or a combination of both to provide the end-users with flexibility to provide optimal comfort during occupied events. (T7350B, D, M, H and T7351F)



Retail

- Customizable Recovery Ramp feature guarantees the exact temperature specified when the store opens, ensuring customer and staff comfort. (All Models)
- Easy-to-use Holiday Scheduler. (All Models)
- For energy management, the T7350 Demand Limit Bump and Demand Limit Control can be programmed with communicating versions of the T7350 to provide energy savings when rooftop units can be staggered to control energy costs during peak periods. (T7350H)



Office Building Zones

- The T7350 is one of the only Honeywell thermostats that integrate with occupancy sensors for office zones that are normally unoccupied or partially occupied. (T7350D, M, H and T7351F)
- T7350 Wall Modules, including the T7771, TR22, TR23 and TR24 models allow for setpoint-only adjustment with range stops, temporary override control or a combination of both to provide the end-users with flexibility to provide optimal comfort during occupied events. (T7350B, D, M, H and T7351F)
- Customizable Recovery Ramp feature guarantees the exact temperature specified when the office opens. (All Models)

Heat Pumps

- Outdoor Air Sensor automatically turns off heat pump equipment in cold climates. The T7350 is the only Honeywell thermostat that uses both an outdoor air sensor and indoor sensors/wall modules for heat pump control applications. (T7350B, D, H and T7351F)

Equipment Protection

- Discharge Air Sensor detects abnormally high or low discharge air temperatures and shuts down equipment if limits are exceeded. (T7350B, D, M, H and T7351F)

Modulating Control — Discharge Air Control

- By tuning the PID loop, optimal control can be achieved. 20K ohm duct sensors can be used in the wall module terminals for temperature sensing. The modulating output will control the damper position. (T7350M, H)

OS Number	Benefit
T7350A1004	Energy Savings, Comfort, Fresh Air
T7350B1002	Energy Savings, Comfort, Fresh Air
T7350D1008	Energy Savings, Comfort, Fresh Air, Dehumidification
T7351F2010	Energy Savings, Comfort, Fresh Air, Dehumidification
T7350M1008	Energy Savings, Comfort, Fresh Air, Dehumidification, Modulating
T7350H1009	Energy Savings, Comfort, Fresh Air, Dehumidification, Communicating
T7350H1017	Energy Savings, Comfort, Fresh Air, Dehumidification, Modulating, Communicating

Modulating Control – Hydronic Boilers and Pumps

- Combine modulating control and on/off relay control. The modulating output can control modulating actuator valves during the heating season and up to 2-stage conventional cooling during the cooling season. (T7350M, H)
- Ideal for split systems that have separate heating and cooling equipment and need both a modulating output and a conventional output. The fan relay can be configured for either conventional (plenum switch controls fan) or electric (thermostat energized fan on call for heat) applications. (T7350M, H)
- Various hydronic control applications are possible, including unit ventilators, fan coils or any other modulating system. The modulating outputs support both direct and reverse acting signals. (T7350M, H)

Communicating Control

- Using the Honeywell Command Display S7760A, the Honeywell LonStation™ front-end or the Honeywell XL15B Web Building Manager, a single user interface can be accessed to perform the following functions: (T7350H)
 - Group Scheduling
 - Group Override/Setback
 - Trending (not supported with command display)
 - Alarming (not supported with command display)
 - Demand Limit Control (XL15B only)
 - LonSpec™ Configuration PC Tool
 - Web-Based Control (XL15B only)
 - Dial-Up Control (LonStation only)

Web-Based Interface

- Using Honeywell's WebStat® Controller in conjunction with the T7350H communicating thermostats allows for a single user interface to be used during system setup, commissioning, monitoring and troubleshooting. With the WebStat Controller, the following functions are enabled:
 - Group Scheduling
 - Group Override-Setback
 - Trending
 - Alarming
 - Custom Graphics and Floorplans





Commercial VisionPRO® 8000

Programmable Touchscreen Thermostat

- Touchscreen user interface
 - The sleek design, menu-driven programming and large touchscreen display are all here
- Saves energy
 - Effortless programming helps your customers save up to 33% off their energy bill¹
- Meets commercial building codes
 - Pre-occupancy Purge, Economizer Output and Override Limits meet all fresh air and override limitation requirements
 - Qualifies for utility rebates²
 - Title 24/IECC/ASHRAE codes
- Multiple lockout levels
 - Save energy and money by preventing unauthorized setting changes
- Compatible with auxiliary commercial devices
 - Commercial sensors
 - Economizers
- Commercial comfort
 - Commercial Algorithm, configurable recovery ramps and temporary override button allow users to control at setpoint and guarantee a comfortable environment

¹ If used as directed. Savings may vary depending on geographic region and usage.

² Where applicable.

OS Number	Description	Application
TB8220U1003	Commercial VisionPRO® 8000 Programmable Thermostat	<ul style="list-style-type: none"> – 2 Heat/2 Cool Conventional – 3 Heat/2 Cool Heat Pump

Replacements					Sensor Compatibility	
	Honeywell	White-Rodgers	Invensys/ Robertshaw	Carrier/Totaline		
Commercial VisionPRO® 8000	TB8220U1003	T7300 with Q7300A2016, Q7300A2008, Q7300C2004 and Q7300C2012 Subbase	IF90 Series, IF80 Series	9800 Series, 9700i Series, 300 Series	P374-2100, P374-2200, P374-2300, 33S250-01, 33CS220-01, 33CS071-01, 33CSSP2-WC, 33CSSN2-WC	TR21, TR21-A (averaging), C7772A1012 (flush mount), C7770A1006 (return air duct), C7041P2004 (button sensor)



CommercialPRO® 7000

Thermostat

- Large, easy-to-read display
 - Screen size is more than double competitive thermostats in this class, allowing for more information to be displayed on the easy-to-view backlit display
- Saves energy
 - Easy-to-use, menu-driven programming helps your customers save up to 33% off energy bills¹
- Meets commercial building codes
 - Pre-occupancy Purge, Economizer Output, and Override Limits meet all fresh air and override limitation requirements
 - Qualifies for utility rebates²
 - Title 24/IECC/ASHRAE code
- Multiple lockout levels
 - Save energy and money by preventing unauthorized setting changes
- Compatible with auxiliary commercial devices
 - Commercial sensors
 - Economizers
- Commercial comfort
 - Commercial Algorithm, configurable recovery ramps and temporary override button allow users to control at setpoint and guarantee a comfortable environment

¹ If used as directed. Savings may vary depending on geographic region and usage.

² Where applicable.

OS Number	Description	Application
TB7220U1012	CommercialPRO® 7000 Programmable Thermostat	<ul style="list-style-type: none"> – 2 Heat/2 Cool Conventional – 3 Heat/2 Cool Heat Pump

Replacements					Sensor Compatibility	
	Honeywell	White-Rodgers	Invensys/ Robertshaw	Carrier/Totaline		
CommercialPRO® 7000	TB7220U1012	T7300 with Q7300A2016, Q7300A2008, Q7300C2004 and Q7300C2012	IF90 Series, IF80 Series	9800 Series, 9700i Series, 300 Series	P374-2100, P374-2200, P374-2300, 33S250-01, 33CS220-01, 33CS071-01, 33CSSP2-WC, 33CSSN2-WC	TR21, TR21-A (averaging), C7772A1012 (flush mount), C7770A1006 (return air duct), C7041P2004 (button sensor)



MultiPRO™ 7000

Multispeed and Multipurpose Thermostat

- Large, easy-to-read display
 - Screen size is more than double competitive thermostats in this class, allowing for more information to be displayed on the easy-to-view backlit display.
- Programmable or non-programmable modes
- Saves energy
 - Effortless programming helps your customers save up to 33% off their energy bill¹
 - Remote setback input for occupancy sensors or timeclocks
 - VersaSpeed™ fan ramping algorithm and auto fan reset algorithm (fan coil and PTAC applications)
- Multiple lockout levels
 - Save energy and money by preventing unauthorized setting changes
- Compatible with commercial sensors
- Commercial comfort
 - Commercial Algorithm, configurable recovery ramps and temporary override button allow users to control at setpoint and guarantee a comfortable environment
- Multispeed and Multipurpose
 - 1 Heat/1 Cool Conventional (single speed)
 - 2 Heat/1 Cool Heat Pump (single speed)
 - 2 Heat/1 Cool PTAC (2 speeds)
 - 2 or 4-pipe Fan Coil (3 speeds)

¹ If used as directed. Savings may vary depending on geographic region and usage.

OS Number	Description	Application
TB7100A1000	MultiPRO™ Multispeed and Multipurpose Thermostat	1 Heat/1 Cool Conventional, 2 Heat/1 Cool Heat Pump, 2 Heat/1 Cool PTAC Systems and 2 or 4-pipe Fan Coil

Replacements						Sensor Compatibility	
	Honeywell	White-Rodgers	Invensys/ Robertshaw	Carrier/Totaline	PSG Controls		
MultiPRO™	TB7100A1000	T8574B2016, T8575B2007, T8575C2005, T8575D2003	IF90-371, IF96-344, IF97-371, IF80-224, IF80-241, IF80-261, IF86-244, IF87-251, IF82-261, IF89-211	97012, 9610, 9700i, 300-224, 300-225, 300-226,	P274-0100, P274-1100, P374-0200, P374-0300	DFC-20YU6585F, DPFC-024U2F, DPFC-024K2F, TDMS24-AH22CB	TR21, TR21-A C7772A1012 (flush mount), C7770A1006 (return air duct), C7041P2004 (button sensor)

Private Label Program

Associate Your Company Name With The Honeywell Brand

- Give your customers the quality and reliability of a Honeywell thermostat
- Let customers know who to call for future HVAC needs
- Up to three full lines of personalization — imprinted directly on the thermostat cover
- Low minimum order quantities — starting at just 48 units
- No annual volume commitments
- Fastest turn-time in the industry — imprint approval in 5 days or less, all orders shipped in 10 days or less*



*Provided all program conditions are met.
Based on product availability.

Program Details

	MIN. ORDER QUANTITY	ORDER PROCESS*	IMPRINT FEE
Initial Orders	48 Units	Through Web site customer.honeywell.com	None
Re-Orders	24 Units	Through Web site customer.honeywell.com	None

Distributor Instructions

Before you begin creating a private label, set up a unique product part number(s) for your customer in your system.

- The part number(s) that you assign must be unique to each customer and each product.
- Maximum of 18 characters per distributor part number. Part numbers must be upper case with no spaces. (For example: TB8220CLIMATRON).
- Do not use Honeywell part number(s) for your customer part numbers. We suggest using a variation such as the example above.
- You must use your distributor part number when ordering private label units.

Web Setup

Free setup on all orders placed through customer.honeywell.com

Log on to customer.honeywell.com using your Distributor Account Number and password* and click on the "Private label Program" link in the right-hand column of the screen. Click on the "Create New Label" link on the secondary menu bar at the top of the screen.

Step 1: Create a Label

- Select the font type.
- Type in your customer's information exactly as they would like it to appear on their thermostats.
- Preview and submit your label when complete.

Step 2: Part Number Setup

- Select the Honeywell thermostat part numbers from the drop-down menu (the description will automatically populate).
- Enter in your customer's unique part number(s).
- Submit for approval and print a copy for your records.
- You will receive approval from Honeywell within 5 days of submittal that part number(s) have been set up and product is available to order.

Step 3: Place Your Order

- Place an order (using your customer's unique part number) after receiving both e-mail confirmations from Honeywell that your label and part number(s) have been approved.

*Contact Honeywell customer care with any questions relating to logging on to customer.honeywell.com.

ALL PRIVATE LABEL ORDERS REQUIRE A MINIMUM INITIAL ORDER QUANTITY OF 48 UNITS. Mix/match is allowed to reach 48 minimum initial order quantity, but must contain a minimum of 24 units per part number. Mix and match products include Commercial VisionPRO®, VisionPRO®, CommercialPRO®, FocusPRO and PRO model families. Please refer to customer.honeywell.com for full OS numbers. Orders must be placed in case quantities of 12. Re-order quantity is 24 units (must be the same part number). Private label orders are non-cancelable.

All private label orders will require a 10-day lead time — from the time submitted label artwork is approved and a purchase order is received from the Wholesaler/Distributor to the time the private label product is shipped by Honeywell. All private labeled orders will be shipped directly to the Wholesaler/Distributor. Honeywell will not hold any inventory on private labeled product. Any change in the label will be treated as a new label creation and the approval process must be followed in total. Coordination will be required for the transition, including purchasing existing stock of customer parts. All private label requests must conform to the standards set by Honeywell. Honeywell reserves the right to deny any private label request as its own discretion. Any inventory in the channel (in the factory in the warehouse or in transit) is the responsibility of the Wholesaler/Distributor. Honeywell will not be liable for any inventory in the channel. By ordering private labeled products, you are agreeing to the terms stated in this program description. Honeywell reserves the right to change or cancel this program without notice.



After-Hours Control in Office Buildings

- The Override button can be configured for a length of time (1, 2, 3, 4 hours) and can be configured for an exact override setpoint through the use of the lockout level set-up and the temperature range stop setup. A user may override to an exact setpoint or be given a setpoint range to choose from.
- Provides comfort during after-hours occupancy while maintaining energy savings after the tenant leaves the building.



Schools – Individual Zone Control

- Cancel Period button allows thermostat to remain in permanent unoccupied mode to provide energy savings for school classrooms not being used.
- Teachers wanting to use a classroom press the Override button and the thermostat enters the occupied period providing the necessary comfort.
- The Override button can be configured for a length of time (1, 2, 3, 4 hours) and can be configured for an exact override setpoint through the use of the lockout level setup and the temperature range stop setup. A user may override to an exact setpoint or be given a setpoint range to choose from.
- During long holidays or during summer vacation, the thermostat can be programmed with the Holiday button to provide the greatest amount of energy savings.



Restaurant/Food Service Control

- Honeywell's Commercial Algorithm provides the best comfort control to react to the challenging environments of food service and restaurant environments. The commercial algorithm is tuned to provide the tightest comfort control and react quickly to changing load demands via fast-sensing time constants.
- Economizer function allows restaurants to meet the appropriate ventilation requirements and is also important to balance the air intake of the restaurant. Restaurants that are not properly balanced do not achieve good comfort control as they draw in unconditioned air.
- Remote sensing configuration options allow the use of commercial 10K ohm and 20K ohm sensors to provide any remote sensing combination (1 to 9+ sensors) to create an averaging network.

Condominiums/Hotels

- Honeywell's MultiPRO™ thermostat uses the patent pending VersaSpeed™ fan ramping algorithm to give multiunit facilities such as hotels, condos, dorms and retirement facilities more control and additional savings through the elimination of unnecessary energy use.
- The fan coil and PTAC applications on the MultiPRO™ make it a perfect thermostat for hotels or condominiums. (See our SuitePRO™ thermostat, too)

Economizer Integration

- Compatible with Honeywell Economizer controllers, which generate free cooling if appropriate outside air and/or humidity conditions exist. (Not available on MultiPRO™)
- Thermostats are integrated with economizers to maintain minimum ventilation requirements of the building during occupied periods. During unoccupied periods, thermostats can override the economizer to fully close the damper, thereby eliminating air infiltration into the building to maximize energy savings.

OS Number	Benefit
TB8220U1003	Energy Savings, Comfort, Fresh Air
TB7220U1012	Energy Savings, Comfort, Fresh Air
TB7100A1000	Energy Savings, Comfort and Versatility

Remote Sensing

Can be configured using Honeywell's line of 10K ohm and 20K ohm commercial sensors, supporting the following applications that residential thermostats don't:

- Temperature Averaging Networks

Because commercial thermostats can be configured to a 20K ohm network, temperature average networks of anywhere from 1 to 9+ sensors can be deployed. Combinations of 10K ohm and 20K ohm sensors are used to create the averaging network. The most popular sensors are the TR21 and TR21-A (averaging) 10K sensor and the TR21 and TR21-A 20K sensor.

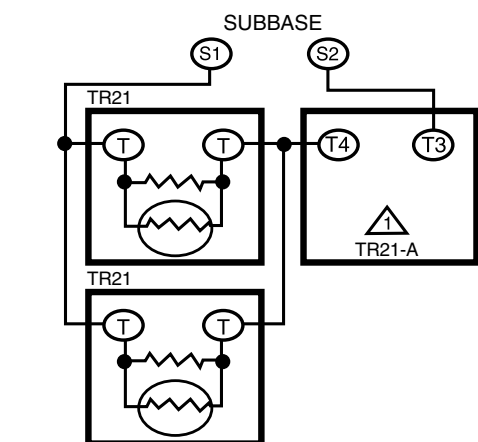

- Room Temperature Control

Performed via a sensing network using the following sensors:

- Wall Sensors: TR21-A (10K) for averaging only, TR21 (20K), C7189U1005 (10K)
- Flush Mount Sensors: C7772A1012 (20K)
- Button Sensors: C7041P (20K)

- Duct Return Temperature Control

Performed using the following 20K sensors: C7041B/C7041C/C7770A/C7041J

Unit Vent

- Can be programmed to control ASHRAE Cycle 1 unit vent applications.
- Unit vent outside-air damper can be programmed through the Economizer feature. When the unit vent is on and occupied, the thermostat will enable the economizer relay to keep the outside air damper at the maximum percentage opening. Only maximum percentage opening is available; the thermostat will not modulate the damper. When the unit vent is unoccupied, the thermostat will close the damper.
- Range Stop feature can be configured to program a low limit setpoint to prevent equipment damage from freezing.

Commercial Codes

- Comply with commercial building codes and meet the most rigorous standard, California's Title 24.
- No hold button is available, so the thermostat remains in permanent schedule.
- Override button allows the tenant to override an unoccupied mode for up to 4 hours and can be configured for an exact override setpoint. Depending on the partial lockout level deployed, a user may override to an exact setpoint or be given a setpoint range to choose from.
- Pre-Occupancy Purge and Economizer functions allow the building owner to meet all HVAC ventilation codes for commercial buildings.

Lighting Load Reduction (TOD)

- Commercial buildings are frequently automated to turn off lighting loads. Lighting loads can use even more energy than HVAC systems in commercial buildings, and 79% of commercial buildings have off-hours lighting load reduction control. By using the time-of-day relay (TOD) in conjunction with a lighting control system, users can automate their lighting loads. (Not available on MultiPRO™)



Infrared Thermostat Interface Module (IR/TIM)

OS #: 50014064-001

- Eliminates hard-to-find cables that connect a Palm® to the thermostat interface module.
- T7350 thermostat programming can be done on the Palm and communicated via infrared to the I/R TIM, which automatically transmits it to the T7350. Simply download the T7350 program software at customer.honeywell.com onto the Palm. Once the T7350 is configured on the Palm, it can be beamed via the infrared port to the I/R TIM.
- Most newer Palms are compatible.
- Programs can be saved on the Palm and beamed again and again to other T7350s, saving time.
- Users can capitalize on more T7350 features that are only accessible by using a Palm, including:
 - 365-day holiday programming
 - Configurable ramp rates
 - Configurable PID loop tuning
 - Configurable standby setpoints
 - Configurable outdoor air temp lockout
 - Configurable high and low discharge air limits
 - Configurable dehumidification parameters



TR21 — 20K Sensor only

TR21-A — 10K Averaging sensor

TR22 — 20K Sensor with setpoint knob

TR23 — 20K Sensor with setpoint knob and override button

T7770D1000 — 20K Sensor with override button

T7771A1005 — 20K or 10K Sensor with setpoint buttons and override button

C7772A1012 — 20K Flush mount sensor

C7041B2005 — 20K Discharge air sensor, 6" probe

C7041B2013 — 20K Discharge air sensor, 12" probe

Humidity Sensors

- Available in wall- or duct-mount applications.
 - Allows for monitoring humidity via a wall sensor or within the return air duct
- Available in different accuracies.
- 2%, 3% or 5% accuracy models for applications requiring different levels of accuracy.

H7625A1008 — 2% RH accuracy wall-mount humidity sensor with 20K room sensor

H7625B1006 — 2% RH accuracy duct-mount humidity sensor with 20K room sensor

H7635A1006 — 3% RH accuracy wall-mount humidity sensor with 20K room sensor

H7635B1004 — 3% RH accuracy duct-mount humidity sensor with 20K room sensor

H7655A1001 — 5% RH accuracy wall-mount humidity sensor

H7655B1009 — 5% RH accuracy duct-mount humidity sensor with 20K room sensor



Remote Room Temperature and Discharge Air Sensors

- Full line of remote wall sensors.
- Gives user the option to have setpoint knobs/buttons, override button or sensor only.
- Flush mount versions are available for high traffic areas where protruding objects would get broken.

Compatible Sensors

Honeywell has a full line of sensors that are compatible with our commercial thermostats.



T7771A1005
Remote Wall
Sensor



TR21
Remote Wall
Sensor



C7772A1012
Remote Flush
Mount Wall
Sensor



C7031G2014
3K Platinum
Outdoor Air
Sensor

Remote Room Sensors	
TR21	20K
TR21-A	10K Averaging
TR22	20K, $\pm 5^\circ$ Setpoint Adj.
TR23	20K, $\pm 5^\circ$ Setpoint Adj. & Bypass
TR24	20K, Bypass
T7771A1005	10K/20K, $\pm 3^\circ$ Setpoint Adj. & Bypass
C7770A1006	Return Air Duct
C7041P2004	Button
C7189U1005	Remote Indoor
C7772A1012	20K Flush Mount Sensor

Remote Humidity Sensors	
H7625A1008	2% Accuracy Wall Mount
H7625B1006	2% Accuracy Duct Mount
H7635A1006	3% Accuracy Wall Mount
H7635B1004	3% Accuracy Duct Mount
H7635C1002	3% Accuracy Outdoor
H7655A1001	5% Accuracy Wall Mount - Humidity only
H7655B1009	5% Accuracy Duct Mount

Discharge Air Sensors	
C7041B2005	20K Discharge Air, 5" Duct Insertion
C7041B2013	20K Discharge Air, 12" Duct Insertion

Outdoor Air Sensors	
C7031G2014	3K Platinum Outdoor Air Sensor
C7170A1002	3K Platinum Outdoor Air Sensor
C7089U1006	C7089 Remote Outdoor Sensor

Remote Pipe Sensor	
PS20	20K Analog Pipe



Economizer

Economizers Compatible with Commercial Thermostats

Honeywell has a range of economizer controls that are compatible with the T7350, T7351, TB8220 and TB7220. These economizers save energy by bringing in cool outdoor air when there is a need for cooling and some models also adjust outdoor damper position based on indoor air quality (CO₂) for demand control ventilation.

- W7459, W7210 (economizer only)
- W7212, W7213, W7214 (economizer and Demand Control Ventilation)

The Demand Control Ventilation economizers listed above have the latest features, including indoor air quality maximum output, night setback terminal and they drive a 2- to 10-volt motor.



ZonePRO®

Commercial Modulating Zoning Thermostat

- Good looks
 - Many thermostats used for this application look very outdated
- Price
 - Very cost-effective alternative to an expensive networked zoning system
- Flexibility
 - Has more features and fits more applications than other thermostats in this market (setback input, additional analog and triac output on the B models)
 - Duct sensor and remote sensor capabilities are standard, allowing flexibility to do room temperature sensing, discharge air control, sensor averaging
- Easy to install
 - Easy to wire
 - Easy to program the configuration code
 - Power output graph helps the installer understand if the actuator is operating properly
- Saves energy
 - Override button and night setback
 - Range stop temperature limits
 - System control modes such as fresh air control and limited cooling modes

	Schedule Options		User Interface	Output Type	Universal Applications	Power Method	Features and Functions					Compatible Actuators	Compatible Valves	Sensors and Accessories	Replaces	
	Program Options	Temporary Override		Modulating and Floating			Permanent Memory Retention	Night Setback	Range Stops	Power Output Graph	Remote Sensing	On-Demand Backlighting				
TB6980A1007	Non-Programmable with Night Setback Input	Yes	Digital	Floating, Single Output	Auto Changeover, Discharge Air Temperature, Return Air Temperature, Room Temperature, Limited Cooling	24 VAC	Yes	Yes	Yes	Yes	Yes (indoor, outdoor, supply)	Yes	ML6984A1006, ML6420, ML6161B2024, MN6105A1011	VC6930, VC6934, VC6936, M6410, M6435	R841 Series of electromechanical relays, 50014157-001 air duct sensor, 50014156-002 space sensor, ST6008A1003 and ST7009A1003 time clocks, 209651A wall plate, D640 and D690 dampers	T6984A1059
TB6980B1006				Floating, Multi Output (extra analog and digital output)									T6984D1046, T6984E1043			
TB7980A1006				Analog (0-10 V or 2-10 V), Single Output									T7984A1057, T7984A1065			
TB7980B1005				Analog (0-10 V or 2-10 V), Multi Output (extra analog and digital output)									T7984B1055, T7984C1053			

ZonePRO® Applications

Stand Alone VAV Pressure Dependent (VVT Zoning) Control

- Typical building applications include zoning for office buildings, airports, strip-malls and multi-tenant facilities that have multiple terminal zones that run off of a single air-handler.
- Thermostats provide modulating control (floating or analog) for each zone.
- Can be configured for cool only, heat only or auto changeover. Up to 2 re-heat outputs are available if the discharge air from the air handler needs to be heated at the zone. (B models)
- Remote sensors are compatible with all ZonePRO® models if remote room sensing or return air temperature sensing is desired.
- May also be used at the air handler to control the temperature of the fresh air supply or provide limited cooling using outdoor air when appropriate.
- All ZonePRO thermostats come with energy-saving range stop and night setback configurability.





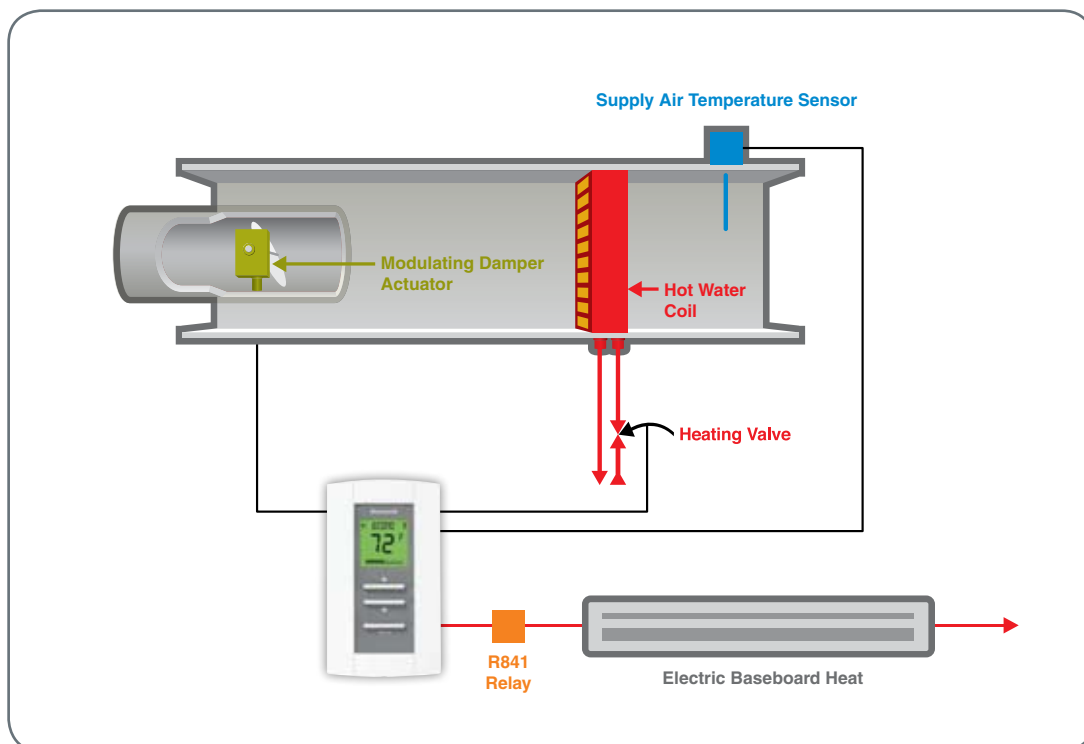

Hydronic Control & Modulating Heating

- Can be used for modulating hydronic heating or cooling applications.
- Other common applications include radiant panel heaters, cabinet heaters, fin-tube radiators and other electric or hydronic re-heat applications.

TB7980B1005: Cooling Only Pressure Dependent VAV Zone Reheat and Electric Baseboard Heat



Honeywell Thermostat Cross-Reference Chart

	MODEL		SCHEDULE OPTIONS				USER INTERFACE	APPLICATION				
			Program Options	ENERGY STAR®	Temporary Override	Holiday		Conventional	Heat Pump	Modulating	Fan Coil	PTAC
	Communicating	T7350H1009	365-Day	•	•	•	Soft Keys	3 Heat / 3 Cool or 2 Heat / 4 Cool	3 Heat / 2 Cool			
		T7350H1017	365-Day	•	•	•	Soft Keys			Two 4-20 mA		
	Modulating	T7350M1008	365-Day	•	•	•	Soft Keys			Two 4-20 mA		
	Conventional/ Heat Pump	T7350D1008	365-Day	•	•	•	Soft Keys	3 Heat / 3 Cool or 2 Heat / 4 Cool	3 Heat / 2 Cool			
		T7350B1002	365-Day	•	•	•	Soft Keys	3 Heat / 2 Cool or 2 Heat / 3 Cool	3 Heat / 2 Cool			
		T7350A1004	365-Day	•	•	•	Soft Keys	1 Heat / 2 Cool or 2 Heat / 1 Cool	2 Heat / 1 Cool			
	Conventional/ Heat Pump	T7351F2010	365-Day	•	•	•	Soft Keys	3 Heat / 3 Cool or 2 Heat / 4 Cool	3 Heat / 2 Cool			
	Commercial VisionPRO® 8000	TB8220U1003	7-Day	•	Cumulative	•	Touchscreen	2 Heat / 2 Cool	3 Heat / 2 Cool			
	CommercialPRO® 7000	TB7220U1012	7-Day	•	Cumulative	•	Soft Keys	2 Heat / 2 Cool	3 Heat / 2 Cool			
	MultiPRO™	TB7100A1000	7-Day	•	Cumulative	•	Soft Keys	1 Heat / 1 Cool	2 Heat / 1 Cool		2 or 4-pipe	2 Heat / 1 Cool

POWER METHOD	FEATURES AND FUNCTIONS									DISPLAY INFORMATION			SENSOR COMPATIBILITY
	Real-Time Clock (Automatically Updates Daylight Savings)	Permanent Memory Retention	Recovery Ramps	LoWorks® Communicating Capability	Economizer Output	Multiple Keypad Lockout Levels	Dehumidification Control	Remote Sensing	Display Size (Viewable)	On-Demand Backlighting	Continuous Backlighting	Simultaneous Display of Room and Set Temperature	
24 VAC	•	•	•	•	•	3	•	Indoor, Outdoor, Discharge, Humidity, Occupancy	4.2 sq. in.		•		TR21, TR21-A, TR21-J, TR22, TR23, TR24, C7772A1012 (flush mount), C7770A1006 (return airduct), C7041P2004 (button sensor)
24 VAC	•	•	•	•	•	3	•	Indoor, Outdoor, Discharge, Humidity, Occupancy	4.2 sq. in.		•		
24 VAC	•	•	•		•	3	•	Indoor, Outdoor, Discharge, Humidity, Occupancy	4.2 sq. in.		•		
24 VAC	•	•	•		•	3	•	Indoor, Outdoor, Discharge, Humidity, Occupancy	4.2 sq. in.		•		
24 VAC	•	•	•		•	3		Indoor, Outdoor, Discharge	4.2 sq. in.		•		
24 VAC	•	•	•		•	3			4.2 sq. in.		•		
24 VAC	•	•	•		•	4	•	Indoor, Outdoor, Discharge, Humidity, Occupancy	4.2 sq. in.		•		
24 VAC or Battery	•	•	•		•	4		Indoor or Outdoor	10 sq. in.	•	•	•	TR21, TR21-A, C7772A1012 (flush mount), C7770A1006 (return air duct), C7041P2004 (button sensor)
24 VAC or Battery	•	•	•		•	4		Indoor or Outdoor	4 sq. in.	•	•	•	TR21, TR21-A, C7772A1012 (flush mount), C7770A1006 (return air duct), C7041P2004 (button sensor)
24 VAC or Battery	•	•	•			5		Indoor and Occupancy	4 sq. in.	•	•	•	TR21, TR21-A, C7772A1012 (flush mount), C7770A1006 (return air duct), C7041P2004 (button sensor)



SuitePRO™ Digital Fan Coil

- Energy savings, aesthetic appeal, and easy to install

TB6575A1000— 2/4 pipe 120/240V fan coil thermostat with manual or auto changeover

TB6575B1000— 2 pipe only 120/240V fan coil thermostat with manual or seasonal changeover

TB8575A1000— 2/4 pipe 24V fan coil thermostat with manual or auto changeover



Electromechanical Fan Coil

- Popular for the replacement market
 - Large installed base, popular proven mechanical design

T4039B1008 — 2/4 pipe 24 V electromechanical fan coil thermostat

T4039M1004 — 2/4 pipe 24 V electromechanical fan coil thermostat with positive off

T4039M1103 — 2/4 pipe 24 V electromechanical fan coil thermostat with positive off (white color) with automatic changeover and fan auto switch

T6169C4015 — 2 pipe fan coil, manual or auto changeover

T6169B4017 — 2 pipe fan coil, manual heat-cool changeover, no fan switching

Other Thermostats



Line Volt

- Simple interface for control of line voltage heaters
 - Easy for occupants to read and change setpoints

T651A3018 — Degree F scale, for heavy-duty line voltage heating systems

T651A3026 — Degree C scale, for heavy-duty line voltage heating systems

T451A3005 — Degree F scale, for light-duty line voltage heating systems



Pneumatic

- Large replacement market
 - Large installed base, popular proven design for pneumatic systems

Go to customer.honeywell.com for a list of all model numbers and accessories.

Learn More

For more information on Honeywell Commercial Thermostats, contact your local Honeywell authorized distributor, call **1-763-954-6464** or visit customer.honeywell.com.

Automation and Control Solutions

In the U.S.:

Honeywell

1985 Douglas Drive North
Golden Valley, MN 55422-3992

In Canada:

Honeywell Limited

35 Dynamic Drive
Toronto, Ontario M1V 4Z9

In Latin America:

Honeywell

9315 N.W. 112th Avenue
Miami, FL 33178
www.honeywell.com

The Honeywell logo is displayed in a bold, red, sans-serif font.