



DONGAN

YOUR SOURCE FOR STANDARD AND CUSTOM TRANSFORMERS

*Engineered solutions for
power and the environment*

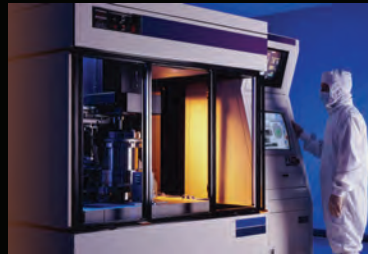

Table of Contents

Single Phase	4
General Purpose	5
Diagrams	12
Series ES-11 CE Marked	15
Series 33 - Control	17
Series HL - Hazardous Location	18
Class 2 Transformers	19
Outline	21
Three Phase	22
General Purpose Vanguard DOE2016	23
76 Series Encapsulated	27
Diagrams	28
Series ES-31 CE Marked	30
Motor Drive Isolation	31
K-Factor & Low Temperature	33
Specialty Transformers	34
Outlines	35
Buck - Boost.....	36
Industrial Control Transformers	50
Century Series.....	51
Series ES-10 CE Marked	59
Series HC	61
Series 50	65
Series AP12 & FP12.....	72
LTG Disconnects.....	74
General Information	85
Corporate History.....	88
Alphanumeric Page Reference	89



THE VANGUARD SERIES Energy Efficient Transformers that meet DOE 2016 Efficiency standards

The Department of Energy (DOE) has mandated improved energy efficiency guidelines for three phase transformers that went into effect on January 1, 2016.

The original Energy Policy and Conservation Act (EPACT) was passed in 2005 and put into effect in 2007, it establishing energy conservation standards for various consumer, commercial and industrial products including certain types of General Purpose dry-type distribution transformers. The Act promotes transformer designs featuring reduced conductor and core losses that will produce considerable energy savings from the installation date and continuing over the life of the product.

The new DOE requirement affects 3 phase transformers only as single phase still remain under the 2005 act. This new ruling not only will save users money in the annual energy costs, it will also help to conserve energy and help the environment in the long term. In fact, the DOE states that the new efficiency levels are expected to reduce energy losses in the range of 15-18% on average on low voltage transformers over the previous TP1 designs.

Cost Savings? Yes The DOE states that the 10 CFR Part 431.192, also known as DOE 2016 will save about \$12.9 billion in total costs to the consumers. The new distribution transformer standards will also save 3.63 quadrillion BTU's of energy for equipment sold over the 30-year period of 2016 to 2045.

The new amendments to the existing efficiency standards would further decrease electrical losses by about 8 percent for liquid-immersed transformers, 13 percent for medium-voltage dry-type transformers, and 18 percent for low-voltage dry-type transformers. In addition, about 264.7 million metric tons of carbon dioxide emissions will be avoided, equivalent to the annual greenhouse gas emissions of about 51.75 million automobiles.

The impact of the legislation places design compliance on distribution transformer manufacturers. EPACT requires all transformers defined in the Act, manufactured subsequent to January 1, 2016, to be compliant with the minimum TP-1 efficiency standards.



Saving Energy

Distribution transformers included by definition in DOE 2016 are those meeting the following criteria:

- Operational frequency of 60 Hz.
- Input voltage of 34.5 kV (34,500 Volts) or less
- Output voltage of 600 volts or less
- Liquid immersed capacity of 10 to 2,500 kVA three phase and 10 to 833 single phase
- Dry-type capacity of 15 to 2,500 kVA three phase and 15 to 833 kVA single phase

Low Voltage Dry-type Distribution:
 1PH 15-333 kVA;
 3PH 15-1000 kVA, ≤10kV BIL

DOE 2016 also provides exclusions for the following types of transformers:

- Uninterruptible power supplies
- Transformers with multiple voltage taps, the highest of which equals at least 20% more than the lowest tap.
- Special-impedance transformers
- Sealed transformers
- Non-ventilated transformers
- Testing transformers
- Grounding transformers
- Drive isolation transformers
(Currently not excluded in Canada)
- Autotransformers
- Rectifier transformers
- Regulating transformers
- Welding transformers
- Machine tool control

Dongan Electric is pleased to introduce our Energy Efficient transformers - engineered to provide reduced cost of ownership over the life of the installation.

Features

- Meets NEMA DOE 2016 energy efficiency standards
- Aluminum or copper windings
- High quality, electrical grade core steel
- 41 & 73 Series have a 220°C Insulation system with a 150°C temperature rise
- 42 & 74 Series are copper wound and have a 220°C Insulation system with a 150°C temperature rise
- 60 Hz
- Wound with electrostatic shields as standard
- Standard enclosures meet NEMA 3R indoor outdoor requirements without the purchase of additional rainshields
- Available wall mount brackets
- Non-standard designs available
- Furnished with vibration dampening pads

Options

- Virtually any voltage combination up to 600 volts may be ordered as TP-1 Compliant.
- Core and Coil Designs
- Lower temperature rises of 80°C and 115°C are available
- 10 Year Warranty

Minimum efficiency ratings are shown in the chart below.

Most installations will be covered by units displayed in this catalog.

Please consult your Dongan Representative or the factory Customer Service Department at 800.428.2626 for price and availability on hundreds of custom designs in our library.

2016 Efficiency Standards

kVa	2007	2016
15	97	97.89
30	97.5	98.23
45	97.7	98.4
75	98	98.6
112.5	98.2	98.74
150	98.3	98.83
225	98.5	98.94
300	98.6	99.02
500	98.7	99.14
750	98.8	99.23
1000	98.9	99.28

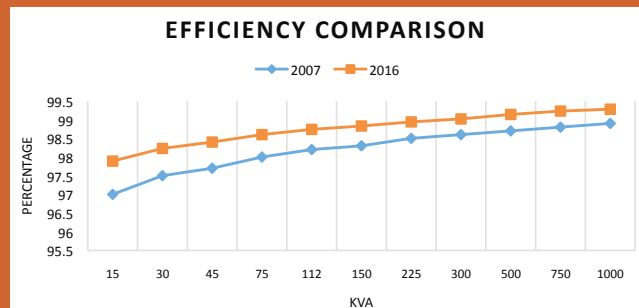

Note: All efficiency values are at 35 percent of nameplate-rated load, determined according to the DOE Test Method for Measuring the Energy Consumption of Distribution Transformers under Appendix A to Subpart K of 10 CFR part 431.

The efficiency of a liquid-immersed distribution transformer manufactured on or after January 1, 2016, shall be no less than that required for their kVA rating in the table below. Liquid-immersed distribution transformers with kVA ratings not appearing in the table shall have their minimum efficiency level determined by linear interpolation of the kVA and efficiency values immediately above and below that kVA rating.

Single Phase - General Purpose

Single Phase Ventilated:

Series 35: .050 kVA - .750 kVA – Series 80: 1.0 kVA - 5.0 kVA

Features



- **Series 35** has a **UL Class 105°C** insulation system
- **Series 80** has a **UL Class 180°C** insulation system
- **NEMA Type 3R**, wall mount enclosure suitable for indoor or outdoor use.
- **Multiple knockouts** provide convenient conduit entry and exit locations through the front access wiring compartment.
- **Ground studs** provided for bonding compatibility with both metallic and nonmetallic conduit.



Single Phase Encapsulated:

Series 85 ISO-Shield: .250 kVA - 25 kVA

Features



- **Electrostatic shield** between primary and secondary windings.
- **Epoxy-silica encapsulated** core and coil provides a transformer particularly well suited for harsh commercial and industrial applications.
- **UL Class 180°C** insulation system
- **NEMA Type 3R**
- **Multiple knockouts** provide convenient conduit entry.
- **Ground studs** provided for bonding compatibility.



Single Phase Ventilated Cabinet Style:

Series 61 and 41 ISO-Shield: 7.5 kVA - 100 kVA

Features



- **Electrostatic shield** between primary and secondary windings
- **Aluminum windings**
- **UL Class 220°C** insulation system
- **NEMA Type 3R**, ventilated, cabinet style, indoor.
- **No extra rainshields required for outdoor use.**
- **Vibration dampening pads** provide quiet operation.
- **Ground studs** provided for bonding compatibility.



Single Phase - General Purpose

Primary Volts 240 X 480
Secondary Volts 120 / 240

General Information				Winding Specifications				Dimensions			
kVA Cap.	Catalog Number	Hz.	Wgt. Lbs	Taps	Maximum Amps		Conn Dia. Pg. 12	Height A	Width B	Depth C	Outline Dwg.
					Pri.	Sec.					
.050	35-1005	50/60	3.3	0	.2 / .1	.4 / .2	1	6.37	3.75	3.37	1
.100	35-1010	50/60	5	0	.4 / .2	.8 / .4	1	6.37	3.75	3.37	1
.150	35-1015	50/60	7	0	.6 / .3	1.2 / .6	1	7.00	4.00	3.63	2
.250	85-1020SH	50/60	14	0	1.0 / .52	2.0 / 1.0	4	12.00	4.87	5.25	3
.500	85-1025SH	50/60	18	0	2.0 / 1.0	4.1 / 2.0	4	12.00	4.87	5.25	3
.750	85-1030SH	50/60	22	0	3.1 / 1.6	6.2 / 3.1	4	12.00	4.87	5.25	3
1.0	85-1035SH	60	29	0	4.1 / 2.0	8.3 / 4.1	4	15.25	5.75	5.87	3
1.5	85-1040SH	60	37	0	6.2 / 3.1	12.5 / 6.2	4	15.25	5.75	5.87	3
2.0	85-1045SH	60	42	0	8.3 / 4.1	16.6 / 8.3	4	15.25	5.75	5.87	3
3.0	85-1050SH	60	62	0	12.5 / 6.2	25.0 / 12.5	4	15.25	8.25	7.87	3
3.0	85-1450SH	60	62	4	12.5 / 6.2	25.0 / 12.5	2	15.25	8.25	7.8	3
5.0	85-1055SH	60	102	0	20.8 / 10.4	41.6 / 20.8	4	15.25	8.25	7.87	3
5.0	85-1455SH	60	102	4	20.8 / 10.4	41.6 / 20.8	2	15.25	8.25	7.87	3
7.5	85-1060SH	60	131	0	31 / 15.6	62 / 31	4	15.75	14.25	8.75	4
7.5	85-1460SH	60	131	4	31 / 15.6	62 / 31	2	15.75	14.25	8.75	4
10	85-1065SH	60	152	0	41 / 20	83 / 41	4	15.75	14.25	8.75	4
10	85-1465SH	60	152	4	41 / 20	83 / 41	2	15.75	14.25	8.75	4
15	85-1070SH	60	270	0	62 / 31	125 / 62	4	19.38	17.56	11.50	4
15	85-1470SH	60	270	4	62 / 31	125 / 62	2	19.38	17.56	11.50	4
25	85-1075SH	60	300	0	104 / 52	208 / 104	4	19.38	17.56	11.50	4
25	85-1475SH	60	300	4	104 / 52	208 / 104	2	19.38	17.56	11.50	4

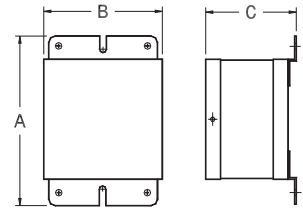

Outline Drawing 1
Wall Mount - Ventilated - NEMA Type 1

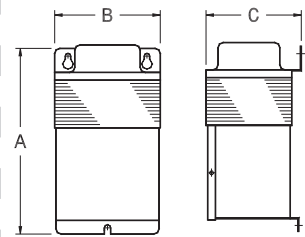

Outline Drawing 2
Wall Mount - Ventilated - NEMA Type 3R

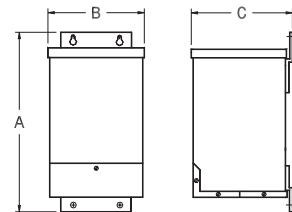

Outline Drawing 3
Wall Mount - Encapsulated - NEMA Type 3R

Note: 3 kVA & 5kVA 85 Series are also available in Outline Drawing 4 Configuration

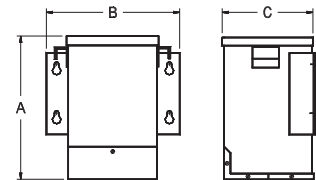

Outline Drawing 4
Wall Mount - Encapsulated - NEMA Type 3R

Floor Mount, Cabinet Style Enclosure

7.5	61-1460SH	60	125	4	31 / 15.6	62 / 31	2	22.00	16.00	16.50	5
10	61-1465SH	60	133	4	41 / 20	83 / 41	2	22.00	16.00	16.50	5
Cabinet Style DOE 2016 Compliant											
15	41-1470SH*	60	185	4	62 / 31	125 / 62	2	23.50	18.63	18.50	5
25	41-1475SH*	60	281	4	104 / 52	208 / 104	2	30.13	21.63	19.50	5
37.5	41-1680SH*	60	384	6	156 / 78	312 / 156	3	32.00	27.00	26.25	5
50	41-1685SH*	60	445	6	208 / 104	416 / 208	3	32.00	27.00	26.25	5
75	41-1690SH*	60	663	6	312 / 156	625 / 312	3	41.00	34.00	26.75	5
100	41-1695SH*	60	732	6	416 / 208	833 / 416	3	41.00	34.00	26.75	5

* Meets DOE requirements

Primary Volts 240 X 480
Secondary Volts 120 - Fused

General Information				Winding Specifications				Dimensions			
kVA Cap.	Catalog Number	Hz.	Wgt. Lbs	Taps	Maximum Amps		Conn Dia. Pg. 13	Height A	Width B	Depth C	Outline Dwg. Pg. 24
					Pri.	Sec.					
.100	35-2010	50/60	5	0	.4 / .2	.8	11	6.37	3.75	3.38	6
.150	35-2015	50/60	7	0	.6 / .3	1.2	11	7.00	4.00	3.63	7
.250	35-2020	50/60	11	0	1.0 / .52	2.0	11	7.50	4.50	4.00	7
.500	35-2025	50/60	20	0	2.0 / 1.0	4.1	11	9.16	5.38	4.56	7
.750	35-2030	50/60	29	0	3.1 / 1.6	6.2	11	10.75	5.50	4.75	7
1.0	80-2035	50/60	29	0	4.1 / 2.0	8.3	11	10.88	5.50	4.75	7
1.5	80-2040	50/60	37	0	6.2 / 3.1	12.5	11	10.19	6.50	5.66	7

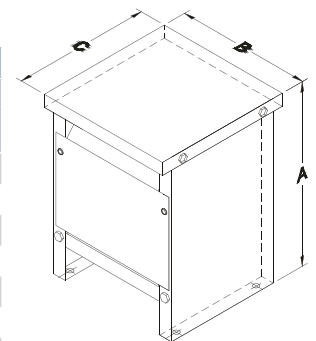

Outline Drawing 5
Floor Mount - Ventilated - NEMA Type 3R

Single Phase - General Purpose

Primary Volts 208, Secondary Volts 120 / 240

General Information				Winding Specifications				Dimensions			
kVA Cap	Catalog Number	Hz	Wgt. Lbs	Taps	Maximum Amp		Conn Dia. Pg. 12	Height A	Width B	Depth C	Outline Dwg.
					Pri	Sec.					
.100	35-3010	50/60	5	0	.4	.8 / .4	5	6.37	3.75	3.37	1
.150	35-3015	50/60	7	0	.7	1.2 / .6	5	7.00	4.00	3.63	2
.250	85-3020SH	50/60	15	0	1.2	2.0 / 1.0	6	12.00	4.87	5.25	3
.500	85-3025SH	50/60	18	0	2.4	4.1 / 2.0	6	12.00	4.87	5.25	3
.750	85-3030SH	50/60	22	0	3.6	6.2 / 3.1	6	12.00	4.87	5.25	3
1.0	85-3035SH	60	29	0	4.8	8.3 / 4.1	6	15.25	5.75	5.87	3
1.5	85-3040SH	60	37	0	7.2	12.5 / 6.2	6	15.25	5.75	5.87	3
2.0	85-3045SH	60	44	0	9.6	16.6 / 8.3	6	15.25	5.75	5.87	3
3.0	85-3050SH	60	62	0	14.4	25.0 / 12.5	6	15.25	8.25	7.87	3
5.0	85-3055SH	60	89	0	24.0	41.6 / 20.8	6	15.25	8.25	7.87	3
7.5	85-3060SH	60	150	0	36	62 / 31	6	15.75	14.25	8.75	4
10	85-3065SH	60	165	0	48	83 / 41	6	15.75	14.25	8.75	4
15	85-3070SH	60	270	0	72	125 / 62	6	19.38	17.56	11.50	4
25	85-3075SH	60	300	0	120	208 / 104	6	19.38	17.56	11.50	4
Cabinet Style DOE 2016 Compliant											
15	41-3470SH*	60	150	4	72	125 / 62	7	23.50	18.63	18.50	5
25	41-3475SH*	60	232	4	120	208 / 104	7	30.13	21.63	19.50	5

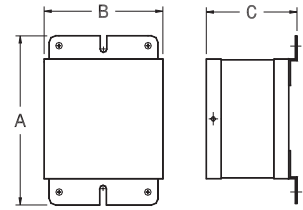

Outline Drawing 1
Wall Mount - Ventilated - NEMA Type 1

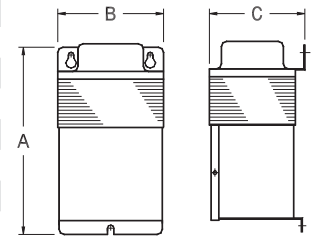

Outline Drawing 2
Wall Mount - Ventilated - NEMA Type 3R

* Meets DOE requirements

Primary Volts 277, Secondary Volts 120 / 240

General Information				Winding Specifications				Dimensions			
kVA Cap	Catalog Number	Hz	Wgt. Lbs	Taps	Maximum Amps		Conn Dia. Pg. 13	Height A	Width B	Depth C	Outline Dwg.
					Pri	Sec					
.100	35-4010	50/60	5	0	.3	.8 / .4	8	6.37	3.75	3.37	1
.150	35-4015	50/60	7	0	.5	1.2 / .6	8	7.00	4.00	3.63	2
.250	85-4020SH	50/60	15	0	.9	2.0 / 1.0	9	12.00	4.87	5.25	3
.500	85-4025SH	50/60	18	0	1.8	4.1 / 2.0	9	12.00	4.87	5.25	3
.750	85-4030SH	50/60	22	0	2.7	6.2 / 3.1	9	12.00	4.87	5.25	3
1.0	85-4035SH	60	29	0	3.6	8.3 / 4.1	9	15.25	5.75	5.87	3
1.5	85-4040SH	60	37	0	5.4	12.5 / 6.2	9	15.25	5.75	5.87	3
2.0	85-4045SH	60	44	0	7.2	16.6 / 8.3	9	15.25	5.75	5.87	3
3.0	85-4050SH	60	62	0	10.8	25.0 / 12.5	9	15.25	8.25	7.87	3
5.0	85-4055SH	60	89	0	18	41.6 / 20.8	9	15.25	8.25	7.87	3
7.5	85-4060SH	60	150	0	27	62 / 31	9	15.75	14.25	8.75	4
10	85-4065SH	60	165	0	36	83 / 41	9	15.75	14.25	8.75	4
15	85-4070SH	60	270	0	54	125 / 62	9	19.38	17.56	11.50	4
25	85-4075SH	60	300	0	90	208 / 104	9	19.38	17.56	11.50	4
Cabinet Style DOE 2016 Compliant											
15	41-4470SH*	60	150	4	54	125 / 62	10	23.50	18.63	18.50	5
25	41-4475SH*	60	232	4	90	208 / 104	10	30.13	21.63	19.50	5

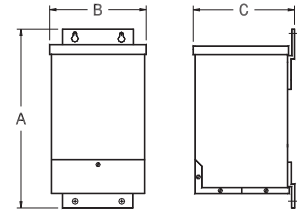

Outline Drawing 3
Wall Mount - Encapsulated - NEMA Type 3R Note: 3 kVA & 5kVA 85 Series are also available in Outline Drawing 4 Configuration

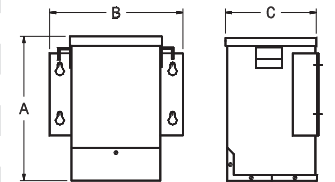

Outline Drawing 4
Wall Mount - Encapsulated - NEMA Type 3R

* Meets DOE requirements

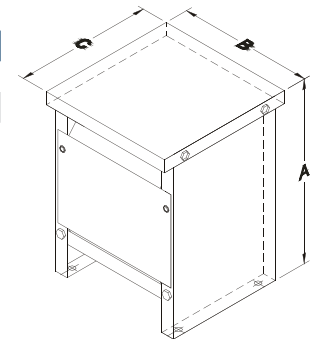

Outline Drawing 5
Floor Mount - Ventilated - NEMA Type 3R

Single Phase - General Purpose

Primary Volts 600 Secondary Volts 120 / 240

General Information				Winding Specifications				Dimensions			
kVA Cap.	Catalog Number	Hz.	Wgt. Lbs	Taps	Maximum Amps		Conn Dia. Pg. 14	Height A	Width B	Depth C	Outline Dwg.
					Pri.	Sec.					
.100	35-5010	50/60	5	0	.1	.8 / .4	12	6.37	3.75	3.37	1
.150	35-5015	50/60	7	0	.2	1.2 / .6	12	7.00	4.00	3.63	2
.250	85-5020SH	50/60	15	0	.4	2.0 / 1.0	13	12	4.87	5.25	3
.500	85-5025SH	50/60	18	0	.8	4.1 / 2.0	13	12	4.87	5.25	3
.750	85-5030SH	50/60	22	0	1.2	6.2 / 3.1	13	12	4.87	5.25	3
1.0	85-5035SH	60	29	0	1.6	8.3 / 4.1	13	15.25	5.75	5.87	3
1.5	85-5040SH	60	37	0	2.5	12.5 / 6.2	13	15.25	5.75	5.87	3
2.0	85-5045SH	60	44	0	3.3	16.6 / 8.3	13	15.25	5.75	5.87	3
3.0	85-5050SH	60	62	0	5.0	25.0 / 12.5	13	15.25	8.25	7.87	3
5.0	85-5055SH	60	89	0	8.3	41.6 / 20.8	13	15.25	8.25	7.87	3
7.5	85-5060SH	60	150	0	12	62 / 31	13	15.75	14.25	8.75	4
10	85-5065SH	60	165	0	16	83 / 41	13	15.75	14.25	8.75	4
15	85-5470SH	60	150	4	25	125 / 62	14	19.38	17.56	11.50	4
25	85-5475SH	60	232	4	41.6	208 / 104	14	19.38	17.56	11.50	4
Cabinet Style DOE 2016 Compliant											
15	41-5470SH*	60	150	4	25	125 / 62	14	23.50	18.63	18.50	5
25	41-5475SH*	60	232	4	41.6	208 / 104	14	30.13	21.63	19.50	5
37.5	41-5480SH*	60	330	4	62	312 / 156	14	32.00	27.00	26.25	5
50	41-5485SH*	60	359	4	83	416 / 208	14	32.00	27.00	26.25	5
75	41-5490SH*	60	524	4	125	625 / 312	14	41.00	34.00	26.75	5
100	41-5495SH*	60	648	4	166	833 / 416	14	41.00	34.00	26.75	5

* Meets DOE requirements

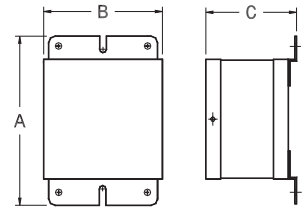

Outline Drawing 1
Wall Mount - Ventilated - NEMA Type 1

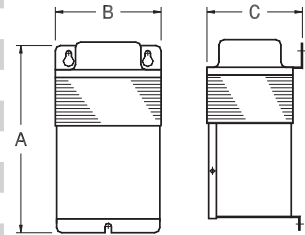

Outline Drawing 2
Wall Mount - Ventilated - NEMA Type 3R

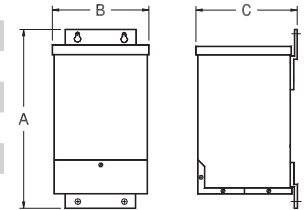

Outline Drawing 3
Wall Mount - Encapsulated - NEMA Type 3R Note: 3 kVA & 5kVA 85 Series are also available in Outline Drawing 4 Configuration

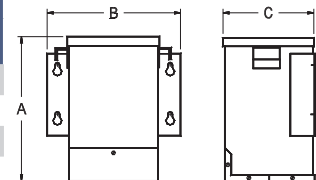

Outline Drawing 4
Wall Mount - Encapsulated - NEMA Type 3R

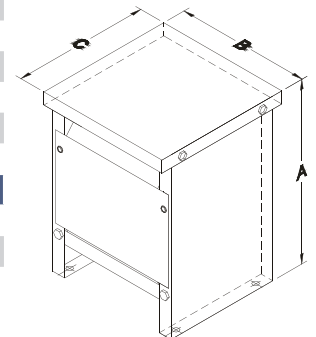

Outline Drawing 5
Floor Mount - Ventilated - NEMA Type 3R

Primary Volts 120 / 240 Secondary Volts 120 / 240

General Information				Winding Specifications				Dimensions			
kVA Cap.	Catalog Number	Hz.	Wgt. Lbs	Taps	Maximum Amps		Conn Dia. Pg. 14	Height A	Width B	Depth C	Outline Dwg.
					Pri.	Sec.					
.100	35-6010	50/60	5	0	.8 / .4	.8 / .4	15	6.37	3.75	3.37	1
.150	35-6015	50/60	7	0	1.2 / .6	1.2 / .6	15	7.00	4.00	3.63	2
.250	85-6020SH	50/60	15	0	2.0 / 1.0	2.0 / 1.0	16	12	4.87	5.25	3
.500	85-6025SH	50/60	18	0	4.1 / 2.0	4.1 / 2.0	16	12	4.87	5.25	3
.750	85-6030SH	50/60	22	0	6.2 / 3.1	6.2 / 3.1	16	12	4.87	5.25	3
1.0	85-6035SH	60	29	0	8.3 / 4.1	8.3 / 4.1	16	15.25	5.75	5.87	3
1.5	85-6040SH	60	37	0	12.5 / 6.2	12.5 / 6.2	16	15.25	5.75	5.87	3
2.0	85-6045SH	60	44	0	16.6 / 8.3	16.6 / 8.3	16	15.25	5.75	5.87	3
3.0	85-6050SH	60	62	0	25.0 / 12.5	25.0 / 12.5	16	15.25	8.25	7.87	3
5.0	85-6055SH	60	89	0	41.6 / 20.8	41.6 / 20.8	16	15.25	8.25	7.87	3
7.5	85-6060SH	60	150	0	62 / 31	62 / 31	16	15.75	14.25	8.75	4
10	85-6065SH	60	165	0	83 / 41	83 / 41	16	15.75	14.25	8.75	4
Cabinet Style DOE 2016 Compliant											
15	41-6470SH*	60	150	4	125 / 62	125 / 62	17	23.50	18.63	18.50	5
25	41-6475SH*	60	232	4	208 / 104	208 / 104	17	30.13	21.63	19.50	5

* Meets DOE requirements

Single Phase - General Purpose Ventilated

Primary Volts 240 X 480 Secondary Volts 120 / 240

General Information				Winding Specifications				Dimensions			
kVA Cap.	Catalog Number	Hz.	Wgt. Lbs	Taps	Maximum Amps		Conn Dia. Pg. 12	Height A	Width B	Depth C	Outline Dwg.
					Pri.	Sec.					
.050	35-1005	50/60	3.3	0	.2 / .1	.4 / .2	1	6.37	3.75	3.37	1
.100	35-1010	50/60	5	0	.4 / .2	.8 / .4	1	6.37	3.75	3.37	1
.150	35-1015	50/60	7	0	.6 / .3	1.2 / .6	1	7.00	4.00	3.63	2
.250	35-1020	50/60	11	0	1.0 / .52	2.0 / 1.0	1	7.50	4.63	4.00	2
.500	35-1025	50/60	20	0	2.0 / 1.0	4.1 / 2.0	1	9.25	5.50	4.75	2
.750	35-1030	50/60	28	0	3.1 / 1.6	6.2 / 3.1	1	10.88	5.50	4.75	2
1.0	80-1035	50/60	29	0	4.1 / 2.0	8.3 / 4.1	1	10.88	5.50	4.75	2
1.5	80-1040	50/60	37	0	6.2 / 3.1	12.5 / 6.2	1	10.63	6.63	5.88	2
2.0	80-1045	60	41	0	8.3 / 4.1	16.6 / 8.3	1	11.00	6.63	5.88	2
3.0	80-1050	60	53	0	12.5 / 6.2	25.0 / 12.5	1	10.88	7.69	6.88	2
5.0	80-1055	60	77	0	20.8 / 10.4	41.6 / 20.8	1	13.69	7.69	6.88	2

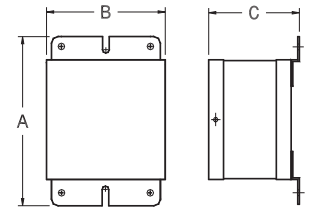

Outline Drawing 1
Wall Mount - Ventilated - NEMA Type 1

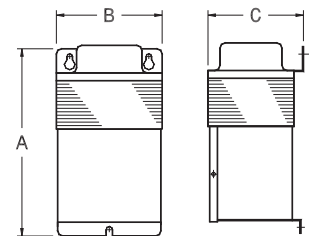

Outline Drawing 2
Wall Mount - Ventilated - NEMA Type 3R

Primary Volts 208 Secondary Volts 120 / 240

General Information				Winding Specifications				Dimensions			
kVA Cap.	Catalog Number	Hz.	Wgt. Lbs	Taps	Maximum Amps		Conn Dia. Pg. 12	Height A	Width B	Depth C	Outline Dwg.
					Pri.	Sec.					
.100	35-3010	50/60	5	0	.4	.8 / .4	5	6.37	3.75	3.37	1
.150	35-3015	50/60	7	0	.7	1.2 / .6	5	7.00	4.00	3.63	2
.250	35-3020	50/60	11	0	1.2	2.0 / 1.0	5	7.50	4.63	4.00	2
.500	35-3025	50/60	20	0	2.4	4.1 / 2.0	5	9.25	5.50	4.75	2
.750	35-3030	50/60	28	0	3.6	6.2 / 3.1	5	10.88	5.50	4.75	2
1.0	80-3035	50/60	29	0	4.8	8.3 / 4.1	5	10.88	5.50	4.75	2
1.5	80-3040	50/60	37	0	7.2	12.5 / 6.2	5	10.63	6.63	5.88	2

Primary Volts 277 Secondary Volts 120 / 240

General Information				Winding Specifications				Dimensions			
kVA Cap.	Catalog Number	Hz.	Wgt. Lbs	Taps	Maximum Amps		Conn Dia. Pg. 13	Height A	Width B	Depth C	Outline Dwg.
					Pri.	Sec.					
.100	35-4010	50/60	5	0	.3	.8 / .4	8	6.37	3.75	3.37	1
.150	35-4015	50/60	7	0	.5	1.2 / .6	8	7.00	4.00	3.63	2
.250	35-4020	50/60	11	0	.9	2.0 / 1.0	8	7.50	4.63	4.00	2
.500	35-4025	50/60	20	0	1.8	4.1 / 2.0	8	9.25	5.50	4.75	2
.750	35-4030	50/60	28	0	2.7	6.2 / 3.1	8	10.88	5.50	4.75	2
1.0	80-4035	50/60	29	0	3.6	8.3 / 4.1	8	10.88	5.50	4.75	2
1.5	80-4040	50/60	37	0	5.4	12.5 / 6.2	8	10.63	6.63	5.88	2

Single Phase - General Purpose Ventilated

Primary Volts 600

Secondary Volts 120 / 240

General Information				Winding Specifications				Dimensions			
kVA Cap.	Catalog Number	Hz.	Wgt. Lbs	Taps	Maximum Amps		Conn Dia. Pg. 13	Height A	Width B	Depth C	Outline Dwg.
					Pri.	Sec.					
.100	35-5010	50/60	5	0	.1	.8/.4	12	6.37	3.75	3.37	1
.150	35-5015	50/60	7	0	.2	1.2/.6	12	7.00	4.00	3.63	2
.250	35-5020	50/60	11	0	.4	2.0/1.0	12	7.50	4.63	4.00	2
.500	35-5025	50/60	20	0	.8	4.1/2.0	12	9.25	5.50	4.75	2
.750	35-5030	50/60	28	0	1.2	6.2/3.1	12	10.88	5.50	4.75	2
1.0	80-5035	50/60	29	0	1.6	8.3/4.1	12	10.88	5.50	4.75	2
1.5	80-5040	50/60	37	0	2.5	12.5/6.2	12	10.63	6.63	5.88	2

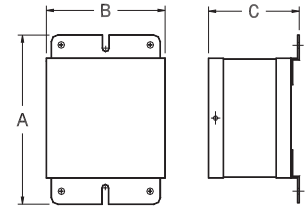

Outline Drawing 1
Wall Mount - Ventilated - NEMA Type 1

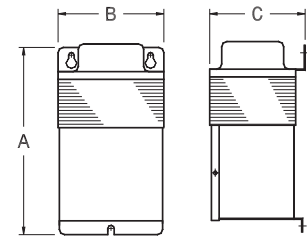

Outline Drawing 2
Wall Mount - Ventilated - NEMA Type 3R

Primary Volts 120 / 240

Secondary Volts 120 / 240

General Information				Winding Specifications				Dimensions			
kVA Cap.	Catalog Number	Hz.	Wgt. Lbs	Taps	Maximum Amps		Conn Dia. Pg. 14	Height A	Width B	Depth C	Outline Dwg.
					Pri.	Sec.					
.100	35-6010	50/60	5	0	.8/.4	.8/.4	15	6.37	3.75	3.37	1
.150	35-6015	50/60	7	0	1.2/.6	1.2/.6	15	7.00	4.00	3.63	2
.250	35-6020	50/60	11	0	2.0/1.0	2.0/1.0	15	7.50	4.63	4.00	2
.500	35-6025	50/60	20	0	4.1/2.0	4.1/2.0	15	9.25	5.50	4.75	2
.750	35-6030	50/60	28	0	6.2/3.1	6.2/3.1	15	10.88	5.50	4.75	2
1.0	80-6035	50/60	29	0	8.3/4.1	8.3/4.1	15	10.88	5.50	4.75	2
1.5	80-6040	50/60	37	0	12.5/6.2	12.5/6.2	15	10.63	6.63	5.88	2

Primary volts 277/480

Secondary Volts 208/277

General Information				Winding Specifications				Dimensions			
kVA Cap.	Catalog Number	Hz.	Wgt. Lbs	Taps	Maximum Amps		Conn Dia.	Height A	Width B	Depth C	Outline Dwg.
					Pri.	Sec.					
0.25	85-8020SH	50/60	15	0	0.9/.52	1.20/0.9	See. Dia. at Right	12	4.87	5.25	3
0.5	85-8025SH	50/60	18	0	1.8/1.04	2.4/1.8		12	4.87	5.25	3
0.75	85-8030SH	50/60	22	0	2.71/1.56	3.61/2.71		12	4.87	5.25	3
1	85-8035SH	60	29	0	3.61/2.08	4.81/3.61		15.25	5.75	5.87	3
1.5	85-8040SH	60	37	0	5.42/3.13	7.21/5.42		15.25	5.75	5.87	3
2	85-8045SH	60	44	0	7.22/4.17	9.62/7.22		15.25	5.75	5.87	3
3	85-8050SH	60	62	0	10.8/6.25	14.4/10.8		15.25	8.25	7.87	3
5	85-8055SH	60	89	0	18/10.42	24/18		15.25	8.25	7.87	3
7.5	85-8060SH	60	150	0	27/15.63	36.05/27		15.75	14.25	8.75	4
10	85-8065SH	60	165	0	36.1/20.83	48/36.1		15.75	14.25	8.75	4
15	85-8070SH	60	270	0	54.2/31.3	72.1/54.2		19.38	17.56	11.5	4

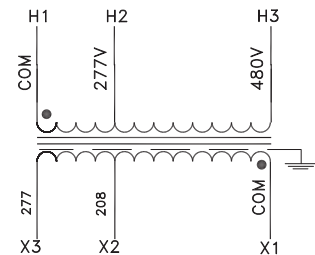

Single Phase - General Purpose Ventilated

PRIMARY VOLTS 240 X 480

SECONDARY VOLTS 120/240 NEMA 4X 304 Stainless Steel

General Information				Winding Specifications				Dimensions			
kVA Cap.	Catalog Number	Hz.	Wgt. Lbs	Taps	Maximum Amps		Conn Dia. Pg. 12	Height A	Width B	Depth C	Outline Dwg.
					Pri.	Sec.					
0.25	FP4X-1020SH	50/60	15	0	1.04/52	2.0/1.0	4	12	4.87	5.25	3
0.5	FP4X-1025SH	50/60	19	0	2.0/1.0	4.1/2.0	4	12	4.87	5.25	3
0.75	FP4X-1030SH	50/60	23	0	3.1/1.6	6.2/3.1	4	12	4.87	5.25	3
1	FP4X-1035SH	60	30	0	4.1/2.0	8.3/4.1	4	15.25	5.75	5.87	3
1.5	FP4X-1040SH	60	3	0	6.2/3.1	12.5/6.2	4	15.25	5.75	5.87	3
2	FP4X-1045SH	60	43	0	8.3/4.1	16.6/8.3	4	15.25	5.75	5.87	3
3	FP4X-1050SH	60	64	0	12.5/6.2	25/12.5	4	15.25	8.25	7.87	3
5	FP4X-1055SH	60	103	0	20.8/10.4	41.6/20.8	4	15.25	8.25	7.87	3
7.5	FP4X-1060SH	60	132	0	31/15.6	62/31	4	15.75	14.25	8.75	4
10	FP4X-1065SH	60	154	0	41/20	83/41	4	15.75	14.25	8.75	4
25	FP4X-1070SH	60	280	0	62/31	125/62	4	19.38	17.56	11.5	4

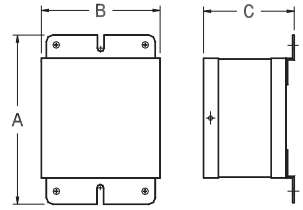

Outline Drawing 1
Wall Mount - Ventilated - NEMA Type 1

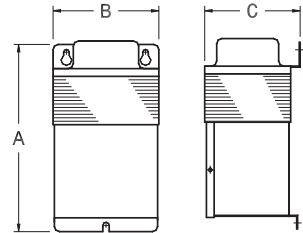

Outline Drawing 2
Wall Mount - Ventilated - NEMA Type 3R

316 stainless available as special order

PRIMARY VOLTS 120/208/240/277

SECONDARY VOLTS 120/240

General Information				Winding Specifications				Dimensions			
kVA Cap.	Catalog Number	Hz.	Wgt. Lbs	Taps	Maximum Amps		Conn Dia.	Height A	Width B	Depth C	Outline Dwg.
					Pri.	Sec.					
1.00	85-1-2915SH	60	23	0	8.3/3.6	8.3/4.1	See Dia. at Right	15.25	5.75	5.87	3
1.50	85-1.5-2915SH	60	30	0	12.5/5.4	12.5/6.3		15.25	5.75	5.87	3
2.00	85-2-2915SH	60	37	0	16.7/7.2	16.7/8.3		15.25	5.75	5.87	3
3.00	85-3-2915SH	60	55	0	25/10.8	25/12.5		15.25	8.25	7.87	3
5.00	85-5-2915SH	60	75	0	41.7/18	41.7/20.8		15.25	8.25	7.87	3
7.50	85-7.5-2915SH	60	105	0	62.5/27	62.5/31.3		15.75	14.25	8.75	4
10.00	85-10-2915SH	60	124	0	83.3/37	83.3/41.7		15.75	14.25	8.75	4
15.00	85-15-2915SH	60	170	0	125/54.1	125/62.5		19.38	17.56	11.5	4

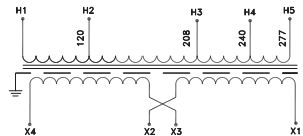

Primary Volts 480,

Secondary Volts 120 / 240

With 2 - 5% FCBN Taps

General Information				Winding Specifications				Dimensions			
kVA Cap.	Catalog Number	Hz.	Wgt. Lbs	Tap Code	Maximum Amps		Conn Dia.	Height A	Width B	Depth C	Outline Dwg.
					Pri.	Sec.					
1.0	80-7235	50/60	29	*	2.0	8.3 / 4.1	See Wind. Dia. at Right	10.88	5.50	4.75	2
1.5	80-7240	50/60	37	*	3.1	12.5 / 6.2		10.63	6.63	5.88	2
2.0	80-7245	60	41	*	4.1	16.6 / 8.3		11.00	6.63	5.88	2
3.0	80-7250	60	53	*	6.2	25.0 / 12.5		10.88	7.69	6.88	2
5.0	80-7255	60	77	*	10.4	41.6 / 20.8		13.69	7.69	6.88	2

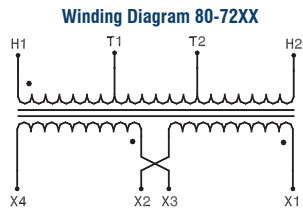

* Tap Configuration for this series is: 2 - 5% FCBN

Single Phase - General Purpose Ventilated

EXPORT MODEL

190/200/208/220 X 380/400/416/440 TO 120/240

General Information				Winding Specifications			Dimensions				
kVA Cap.	Catalog Number	Hz.	Wgt. Lbs	Taps	Maximum Amps		Conn Dia.	Height A	Width B	Depth C	Outline Dwg.
					Pri.	Sec.					
1	ES-13200.406	50/60	60	0	5.26..2.27	8.33/4.1	See Dia. at Right	15.25	5.75	5.87	3
2	ES-13230.406	50/60	70	0	10.5/4.55	16.6/8.3		15.25	5.75	5.87	3
3	ES-13250.406	50/60	95	0	15.8..6.82	25/12.5		15.25	5.75	5.87	3
5	ES-13300.406	50/60	125	0	26.3..11.4	41.6/20.5		15.25	8.25	7.87	3
7.5	ES-13330.406	50/60	150	0	39.5..17	62.5/31		15.25	8.25	7.87	3
10	ES-13360.406	50/60	240	0	52.7/22.7	83.3/42		15.75	14.25	8.75	4
15	ES-13380.406	50/60	320	0	79..34	125/62.5		15.75	14.25	8.75	4
25	ES-13410.406	50/60	400	0	131.6..56.8	208.3/104	19.38	17.56	11.5	4	

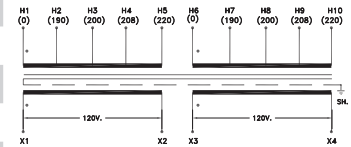

EXPORT MODEL

190/200/208/220 X 380/400/416/440 TO 110/220

General Information				Winding Specifications			Dimensions				
kVA Cap.	Catalog Number	Hz.	Wgt. Lbs	Taps	Maximum Amps		Conn Dia.	Height A	Width B	Depth C	Outline Dwg.
					Pri.	Sec.					
1	ES-13200.344	50/60	60	0	5.26..2.27	9/4.5	See Dia. at Right	15.25	5.75	5.87	3
2	ES-13230.344	50/60	70	0	10.5/4.55	18.1/9		15.25	5.75	5.87	3
3	ES-13250.344	50/60	95	0	15.8..6.82	27.3/13.6		15.25	5.75	5.87	3
5	ES-13300.344	50/60	125	0	26.3..11.4	45.4/22.7		15.25	8.25	7.87	3
7.5	ES-13330.344	50/60	150	0	39.5..17	68.2/34		15.25	8.25	7.87	3
10	ES-13360.344	50/60	240	0	52.7/22.7	90.9/45.5		15.75	14.25	8.75	4
15	ES-13380.344	50/60	320	0	79..34	136.3/68.2		15.75	14.25	8.75	4
25	ES-13410.344	50/60	400	0	131.6..56.8	227.3/113.6	19.38	17.56	11.5	4	

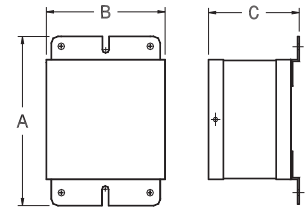

Outline Drawing 1
Wall Mount - Ventilated - NEMA Type 1

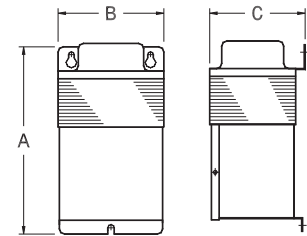

Outline Drawing 2
Wall Mount - Ventilated - NEMA Type 3R

EXPORT MODEL

190/200/208/220 X 380/400/416/440/480 TO 120/240

General Information				Winding Specifications			Dimensions				
kVA Cap.	Catalog Number	Hz.	Wgt. Lbs	Taps	Maximum Amps		Conn Dia.	Height A	Width B	Depth C	Outline Dwg.
					Pri.	Sec.					
1	ES-13200.498	50/60	60	0	5.26..2.27	8.33/4.1	See Dia. at Right	15.25	5.75	5.87	3
2	ES-13230.498	50/60	70	0	10.5/4.55	16.6/8.3		15.25	5.75	5.87	3
3	ES-13250.498	50/60	95	0	15.8..6.82	25/12.5		15.25	5.75	5.87	3
5	ES-13300.498	50/60	125	0	26.3..11.4	41.6/20.5		15.25	8.25	7.87	3
7.5	ES-13330.498	50/60	150	0	39.5..17	62.5/31		15.25	8.25	7.87	3
10	ES-13360.498	50/60	240	0	52.7/22.7	83.3/42		15.75	14.25	8.75	4
15	ES-13380.498	50/60	320	0	79..34	125/62.5		15.75	14.25	8.75	4
25	ES-13410.498	50/60	400	0	131.6..56.8	208.3/104	19.38	17.56	11.5	4	

Single Phase Connection Diagrams

Dia. 1		Catalog Series 35-10XX & 80-10XX			
Tap Arrangement		None			
% High Voltage	High Voltage 240 X 480	Inter-Connect	Connect High Voltage Lines To		
100	240	H1 To H3 H2 To H4	H1H3 & H2H4		
100	480	H2 To H3	H1 & H4		
% Low Voltage	Low Voltage 120 / 240	Inter-Connect	Connect Low Voltage Lines To		
100	120	X1 To X3 X2 To X4	X1X3 & X2X4		
100	120 / 240	X2 To X3	X1 & X2X3 & X4		
100	240	X2 To X3	X1 & X4		

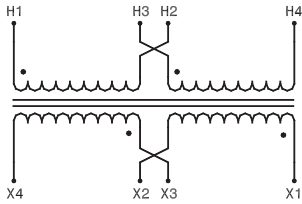

Dia. 2		Catalog Series 85-14XXSH & 61-14XXSH			
Tap Arrangement		2 - 2½ FCAN (Full Capacity Above Normal) 2 - 2½ FCBN (Full Capacity Below Normal)			
% High Voltage	High Voltage 240 X 480	Inter-Connect	Connect High Voltage Lines To		
105	252	H1 To 2 H2 To 1	H1 & H2		
100	240	H1 To 4 H2 To 3			
95	228	H1 To 6 H2 To 5			
105	504	1 To 2			
102.5	492	2 To 3			
100	480	3 To 4			
97.5	468	4 To 5			
95	456	5 To 6			
% Low Voltage	Low Voltage 120 / 240	Inter-Connect	Connect Low Voltage Lines To		
100	120	X1 To X3 X2 To X4	X1X3 & X2X4		
100	120 / 240	X2 To X3	X1 & X2X3 & X4		
100	240	X2 To X3	X1 & X4		

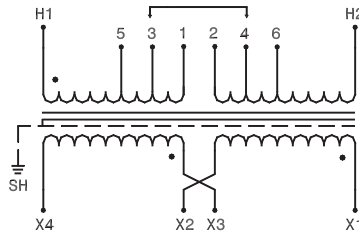

Dia. 3		Catalog Series 41-16XXSH			
Tap Arrangement		2 - 2½ FCAN (Full Capacity Above Normal) 4 - 2½ FCBN (Full Capacity Below Normal)			
% High Voltage	High Voltage 240 X 480	Inter-Connect	Connect High Voltage Lines To		
105	252	H1 To 2 H2 To 1	H1 & H2		
100	240	H1 To 4 H2 To 3			
95	228	H1 To 6 H2 To 5			
90	216	H1 To 8 H2 To 7			
105	504	1 To 2			
102.5	492	2 To 3			
100	480	3 To 4			
97.5	468	4 To 5			
95	456	5 To 6			
92.5	444	6 To 7			
90	432	7 To 8			
% Low Voltage	Low Voltage 120 / 240	Inter-Connect	Connect Low Voltage Lines To		
100	120	X1 To X3 X2 To X4	X1X3 & X2X4		
100	120 / 240	X2 To X3	X1 & X2X3 & X4		
100	240	X2 To X3	X1 & X4		

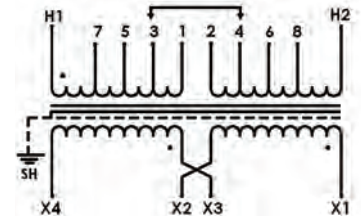

Dia. 4		Catalog Series 85-10XXSH FP4X			
Tap Arrangement		None			
% High Voltage	High Voltage 240 X 480	Inter-Connect	Connect High Voltage Lines To		
100	240	H1 To H3 H2 To H4	H1H3 & H2H4		
100	480	H2 To H3	H1 & H4		
% Low Voltage	Low Voltage 120 / 240	Inter-Connect	Connect Low Voltage Lines To		
100	120	X1 To X3 X2 To X4	X1X3 & X2X4		
100	120 / 240	X2 To X3	X1 & X2X3 & X4		
100	240	X2 To X3	X1 & X4		

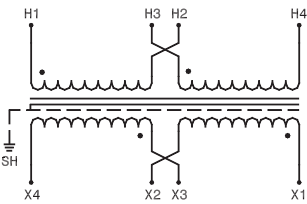

Dia. 5		Catalog Series 35-30XX & 80-30XX			
Tap Arrangement		None			
% High Voltage	High Voltage 208	Inter-Connect	Connect High Voltage Lines To		
100	208	--	H1 & H2		
% Low Voltage	Low Voltage 120 / 240	Inter-Connect	Connect Low Voltage Lines To		
100	120	X1 To X3 X2 To X4	X1X3 & X2X4		
100	120 / 240	X2 To X3	X1 & X2X3 & X4		
100	240	X2 To X3	X1 & X4		

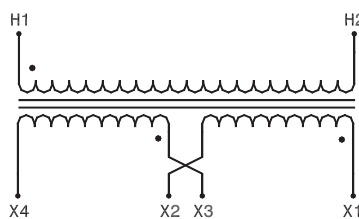

Dia. 6		Catalog Series 85-30XXSH			
Tap Arrangement		None			
% High Voltage	High Voltage 208	Inter-Connect	Connect High Voltage Lines To		
100	208	--	H1 & H2		
% Low Voltage	Low Voltage 120 / 240	Inter-Connect	Connect Low Voltage Lines To		
100	120	X1 To X3 X2 To X4	X1X3 & X2X4		
100	120 / 240	X2 To X3	X1 & X2X3 & X4		
100	240	X2 To X3	X1 & X4		

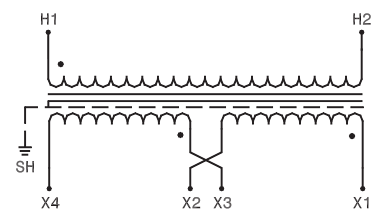

Single Phase Connection Diagrams

Dia. 7		Catalog Series 41-34XXSH		
Tap Arrangement	2-2½ % FCAN (Full Capacity Above Normal) 2-2½ % FCBN (Full Capacity Below Normal)			
% High Voltage	High Voltage	Inter-Connect	Connect High Voltage Lines To	
	208		H1 & H2	
105	218	1 To 2		
102.5	213	2 To 3		
100	208	3 To 4		
97.5	203	4 To 5		
95	198	5 To 6		
% Low Voltage	Low Voltage	Inter-Connect	Connect Low Voltage Lines To	
	120 / 240		H1 & H2	
100	120	X1 To X3 X2 To X4	X1X3 & X2X4	
100	120 / 240	X2 To X3	X1 & X2X3 & X4	
100	240	X2 To X3	X1 & X4	

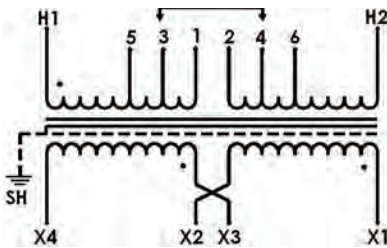

Dia. 8		Catalog Series 35-40XX & 80-40XX		
Tap Arrangement	None			
% High Voltage	High Voltage	Inter-Connect	Connect High Voltage Lines To	
	277		H1 & H2	
100	277	--	H1 & H2	
% Low Voltage	Low Voltage	Inter-Connect	Connect Low Voltage Lines To	
	120 / 240		H1 & H2	
100	120	X1 To X3 X2 To X4	X1X3 & X2X4	
100	120 / 240	X2 To X3	X1 & X2X3 & X4	
100	240	X2 To X3	X1 & X4	

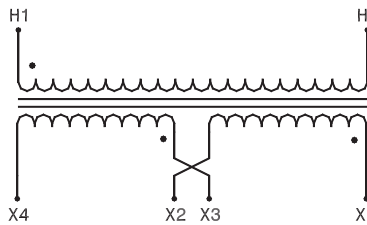

Dia. 9		Catalog Series 85-40XXSH		
Tap Arrangement	None			
% High Voltage	High Voltage	Inter-Connect	Connect High Voltage Lines To	
	277		H1 & H2	
100	277	--	H1 & H2	
% Low Voltage	Low Voltage	Inter-Connect	Connect Low Voltage Lines To	
	120 / 240		H1 & H2	
100	120	X1 To X3 X2 To X4	X1X3 & X2X4	
100	120 / 240	X2 To X3	X1 & X2X3 & X4	
100	240	X2 To X3	X1 & X4	

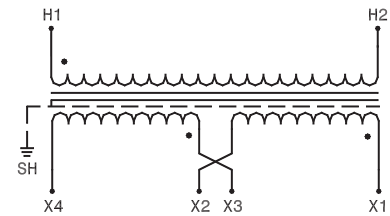

Dia. 10		Catalog Series 41-44XXSH		
Tap Arrangement	2-2½ % FCAN (Full Capacity Above Normal) 2-2½ % FCBN (Full Capacity Below Normal)			
% High Voltage	High Voltage	Inter-Connect	Connect High Voltage Lines To	
	277		H1 & H2	
105	291	1 To 2		
102.5	284	2 To 3		
100	277	3 To 4		
97.5	270	4 To 5		
95	263	5 To 6		
% Low Voltage	Low Voltage	Inter-Connect	Connect Low Voltage Lines To	
	120 / 240		H1 & H2	
100	120	X1 To X3 X2 To X4	X1X3 & X2X4	
100	120 / 240	X2 To X3	X1 & X2X3 & X4	
100	240	X2 To X3	X1 & X4	

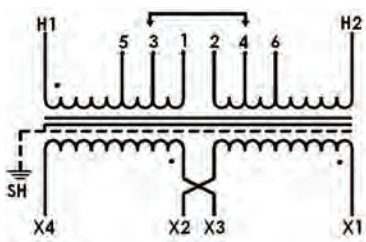

Dia. 11		Catalog Series 35-20XX & 80-20XX		
Tap Arrangement	None			
% High Voltage	High Voltage	Inter-Connect	Connect High Voltage Lines To	
	240 X 480		H1 & H2	
100	240	H1 To H3 H2 To H4	H1H3 & H2H4	
100	480	H2 To H3	H1 & H4	
% Low Voltage	Low Voltage	Inter-Connect	Connect Low Voltage Lines To	
	120 Fused		H1 & H2	
100	120	-	X1 & X2	

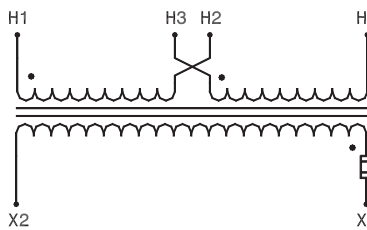

Dia. 12		Catalog Series 35-50XX & 80-50XX		
Tap Arrangement	None			
% High Voltage	High Voltage	Inter-Connect	Connect High Voltage Lines To	
	600		H1 & H2	
100	600	--	H1 & H2	
% Low Voltage	Low Voltage	Inter-Connect	Connect Low Voltage Lines To	
	120 / 240		H1 & H2	
100	120	X1 To X3 X2 To X4	X1X3 & X2X4	
100	120 / 240	X2 To X3	X1 & X2X3 & X4	
100	240	X2 To X3	X1 & X4	

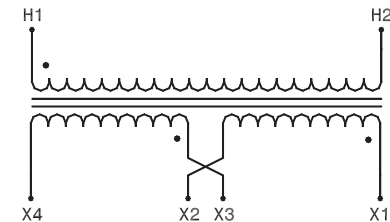

Single Phase Connection Diagrams

Dia. 13		Catalog Series 85-50XXSH		
Tap Arrangement	None			
% High Voltage	High Voltage	Inter-Connect	Connect High Voltage Lines To	
100	600	--	H1 & H2	
% Low Voltage	Low Voltage	Inter-Connect	Connect Low Voltage Lines To	
100	120	X1 To X3 X2 To X4	X1X3 & X2X4	
100	120 / 240	X2 To X3	X1 & X2X3 & X4	
100	240	X2 To X3	X1 & X4	

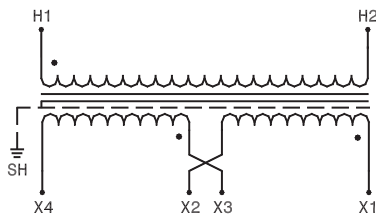

Dia. 14		Catalog Series 41-54XXSH		
Tap Arrangement	2-2½ % FCAN (Full Capacity Above Normal) 2-2½ % FCBN (Full Capacity Below Normal)			
% High Voltage	High Voltage	Inter-Connect	Connect High Voltage Lines To	
105	630	1 To 2	H1 & H2	
102.5	615	2 To 3		
100	600	3 To 4		
97.5	585	4 To 5		
95	570	5 To 6		
% Low Voltage	Low Voltage	Inter-Connect	Connect Low Voltage Lines To	
100	120	X1 To X3 X2 To X4	X1X3 & X2X4	
100	120 / 240	X2 To X3	X1 & X2X3 & X4	
100	240	X2 To X3	X1 & X4	

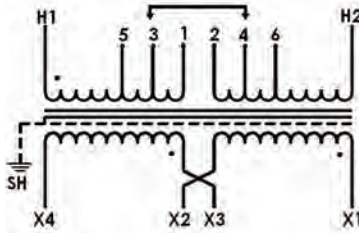

Dia. 15		Catalog Series 35-60XX & 80-60XX		
Tap Arrangement	None			
% High Voltage	High Voltage	Inter-Connect	Connect High Voltage Lines To	
100	120	H1 To H3 H2 To H4	H1H3 & H2H4	
100	240	H2 To H3	H1 & H4	
% Low Voltage	Low Voltage	Inter-Connect	Connect Low Voltage Lines To	
100	120	X1 To X3 X2 To X4	X1X3 & X2X4	
100	120 / 240	X2 To X3	X1 & X2X3 & X4	
100	240	X2 To X3	X1 & X4	

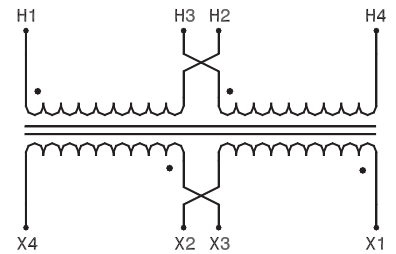

Dia. 16		Catalog Series 85-60XXSH		
Tap Arrangement	None			
% High Voltage	High Voltage	Inter-Connect	Connect High Voltage Lines To	
100	120	H1 To H3 H2 To H4	H1H3 & H2H4	
100	240	H2 To H3	H1 & H4	
% Low Voltage	Low Voltage	Inter-Connect	Connect Low Voltage Lines To	
100	120	X1 To X3 X2 To X4	X1X3 & X2X4	
100	120 / 240	X2 To X3	X1 & X2X3 & X4	
100	240	X2 To X3	X1 & X4	

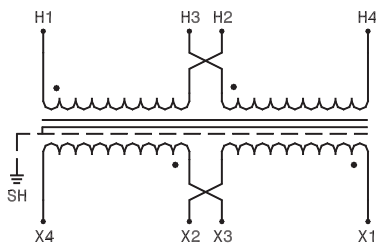

Dia. 17		Catalog Series 41-64XXSH		
Tap Arrangement	2 - 2½ % FCAN (Full Capacity Above Normal) 2 - 2½ % FCBN (Full Capacity Below Normal)			
% High Voltage	High Voltage	Inter-Connect	Connect High Voltage Lines To	
105	126	H1 To 2 H2 To 1	H1 & H2	
100	120	H1 To 4 H2 To 3		
95	114	H1 To 6 H2 To 5		
105	252	1 To 2		
102.5	246	2 To 3		
100	240	3 To 4	H1 & H2	
97.5	234	4 To 5		
95	228	5 To 6		
% Low Voltage	Low Voltage	Inter-Connect	Connect Low Voltage Lines To	
100	120	X1 To X3 X2 To X4	X1X3 & X2X4	
100	120 / 240	X2 To X3	X1 & X2X3 & X4	
100	240	X2 To X3	X1 & X4	

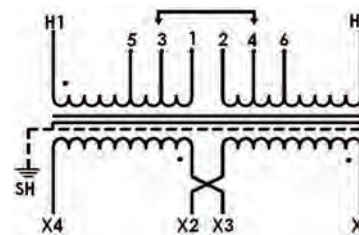

European Series CE Marked ES-11 Single Phase Transformers

Series ES Single Phase Encapsulated Transformers are designed to comply with Domestic, North American, and European Union electrical and testing standards. Series ES are UL and Canadian UL Listed by Underwriters Labs. In addition, Series ES are CE Marked, and licensed by the German testing agency TÜV Rheinland under.

Series ES transformers are the answer to your export needs. With the voltage combinations listed below, and built in approvals, the ES Series provide no-nonsense solutions for equipment destined for the European Community of nations.

Dongan® provides finger safe terminals on all transformers.

The voltage combinations offered represent some of the most universally used. However, any combination of primary and secondary incorporating voltages of 600 volts and below is available on a short lead time, special order basis.

NEMA Type 3R- IP23 available

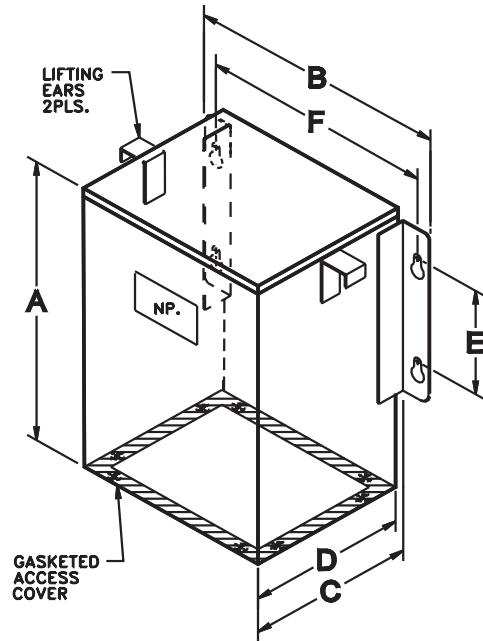

Series ES-11
Wall Mount - Encapsulated - NEMA Type 12 - IP54

General Information									
Pri. Volts	380/400/416/440 460/480/575	220/380/400/416	Dimensions (inches)						Weight (lbs)
Sec. Volts	110/115/120	120/240	A	B	C	Mounting			
kVA Cap.	Catalog Number	Catalog Number	A	B	C	D	E	F	Weight (lbs)
.250	ES-11130.326	ES-11130.359	10.50	10.00	6.62	6.12	4.00	8.50	35
.500	ES-11170.326	ES-11170.359	10.50	10.00	6.62	6.12	4.00	8.50	45
.750	ES-11190.326	ES-11190.359	10.50	10.00	6.62	6.12	4.00	8.50	55
1.0	ES-11200.326	ES-11200.359	12.00	10.81	7.19	6.69	6.00	9.13	75
1.5	ES-11210.326	ES-11210.359	14.00	14.00	9.25	8.75	8.00	12.00	90
2.0	ES-11230.326	ES-11230.359	14.00	14.00	9.25	8.75	8.00	12.00	110
3.0	ES-11250.326	ES-11250.359	14.00	14.00	9.25	8.75	8.00	12.00	120
5.0	ES-11300.326	ES-11300.359	14.00	14.38	10.00	9.50	8.00	12.38	150
7.5	ES-11330.326	ES-11330.359	15.00	18.00	12.50	12.00	8.00	16.00	165
10.0	ES-11360.326	ES-11360.359	15.00	18.00	12.50	12.00	8.00	16.00	190
15.0	ES-11380.326	ES-11380.359	15.00	18.00	12.50	12.00	8.00	16.00	270
25.0	ES-11410.326	ES-11410.359	18.00	21.00	15.00	14.50	8.00	19.00	350

Single Phase Transformers

Features

Agency Compliance



- NEMA Type 12, IP54 enclosure.
- IEC type finger safe terminals.
- 220°C (H) Insulation System.
- 50/60 Hertz.
- ES provided with an electrostatic shield.
- ES provided with protective earth (PE) terminal.



Suffix .326				
Primary Connections		Secondary Connections		
Pri. Voltage	Connect Incoming Lines To:	Sec. Voltage	Connect Load Lines To:	
380	H1 & H3	110	X1 & X3	
400	H1 & H3	115	X1 & X3	
416	H1 & H4	115	X1 & X4	
440	H1 & H4	120	X1 & X4	
460	H1 & H4	115	X1 & X3	
480	H1 & H4	120	X1 & X3	
575	H1 & H5	120	X1 & X4	

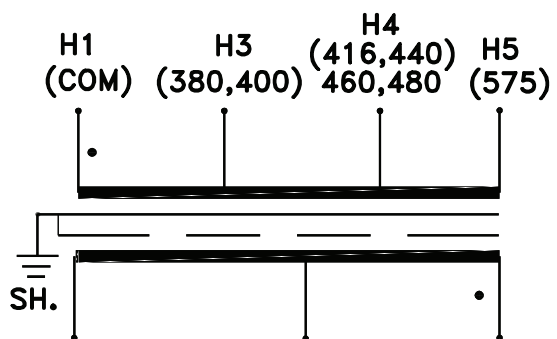

Suffix .359				
Primary Connections		Secondary Connections		
Pri. Voltage	Connect Incoming Lines To:	Sec. Voltage	Interconnect	Connect Load Lines To:
220	H1 & H3	120	X1 to X3 X2 to X4	X1 & X4
380	H1 & H4	240	X2 to X3	X1 & X4
400	H1 & H5	120/240	X2 to X3	X1 & X2X3 & X4
416	H1 & H6			

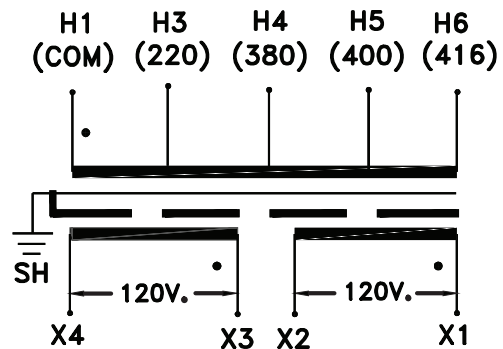

Series 33 - Control Transformers

Series 33 Control Transformers are designed with a NEMA Type 1, indoor type enclosure and are fitted with 8" leads exiting through a 1/2" chase nipple. Dual mounting provisions are provided for both foot mount or direct knockout mount in point of use applications.

Typical applications include voltage reduction for solenoids, magnetic switches, control valves, as well as many other HVAC applications.

Features



- NEMA Type 1.
- Available with manually resettable circuit breakers.
- Dual mounting capability.

General Information			Capacity		Dimensions					
kVA Cap.	Catalog Number	Wgt. Lbs	Maximum Amps		Height A	Width B	Depth C	Mounting		Slot Size F
			Pri.	Sec.				D	E	
Primary 240 Volts, Secondary Volts 120, 50 / 60 Hz										
.050	33-050-H	2.7	.20	.41	3.19	3.00	2.50	1.69	2.50	.188 x .344
.100	33-100-H	4	.41	.83	3.63	3.38	2.81	2.13	2.50	.188 x .375
Primary Volts, 240 x 480, Secondary Volts 24, 50 / 60 Hz										
.050	33-050-HLK	2.7	.20 / .10	2.08	3.19	3.00	2.50	1.69	2.50	.188 x .344
.100	33-100-HLK	4	.41 / .21	4.16	3.63	3.38	2.81	2.13	2.50	.188 x .375
Primary Volts 120, Secondary 24, 50 / 60 Hz										
.050	33-050-K	2.7	.41	2.08	3.19	3.00	2.50	1.69	2.50	.188 x .344
.100	33-100-K	4	.83	4.16	3.63	3.38	2.81	2.13	2.50	.188 x .375
Primary Volts 240 x 480, Secondary Volts 120, 50 / 60 Hz										
.050	33-050-PM	2.7	.20 / .10	.41	3.19	3.00	2.50	1.69	2.50	.188 x .344
.100	33-100-PM	4	.41 / .21	.83	3.63	3.38	2.81	2.13	2.50	.188 x .375
.150	33-150-PM	6	.62 / .31	1.25	4.00	3.75	3.13	2.38	3.25	.219 x .375
.250	33-250-PM	9	1.0 / .52	2.08	4.25	3.75	4.500	3.125	3.250	.219 x .438
Primary Volts 208, Secondary Volts, 120, 50 / 60 Hz										
.050	33-050-17	2.7	.24	.41	3.19	3.00	2.50	1.69	2.50	.188 x .344
.100	33-100-17	4	.48	.83	3.63	3.38	2.81	2.13	2.50	.188 x .375
Primary Volts 208, Secondary Volts 24, 50 / 60 Hz										
.050	33-050-18	2.7	.24	2.08	3.19	3.00	2.50	1.69	2.50	.188 x .344
.100	33-100-18	4	.48	4.16	3.63	3.38	2.81	2.13	2.50	.188 x .375
Primary Volts 277, Secondary Volts 24, 50 / 60 Hz										
.050	33-050-26	2.7	.18	2.08	3.19	3.00	2.50	1.69	2.50	.188 x .344
.100	33-100-26	4	.36	4.16	3.63	3.38	2.81	2.13	2.50	.188 x .375
Primary Volts 277, Secondary Volts 120, 50 / 60 Hz										
.050	33-050-82	2.7	.18	.41	3.19	3.00	2.50	1.69	2.50	.188 x .344
.100	33-100-82	4	.36	.83	3.63	3.38	2.81	2.13	2.50	.188 x .375

Dimensions & weights may change. Consult factory for certified drawings.

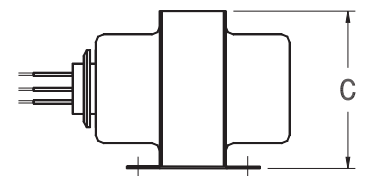
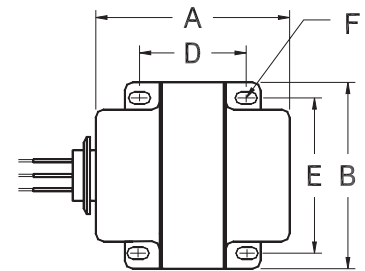

SINGLE PRIMARY

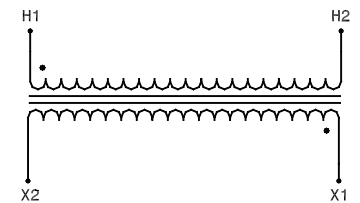

DUAL PRIMARY

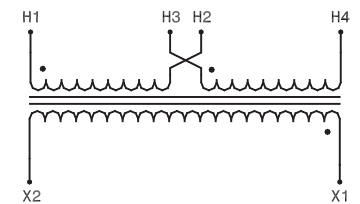

Series HL - Hazardous Location

Series HL - Hazardous Location Transformers are designed for applications where the possibility of a fire or explosion may result from sparks in environments containing high concentrations of dust, gases or other volatile substances.

Series HL transformer's wiring compartments are completely filled with electrical grade silica and resin, leaving no access to the core and coil or other internal components.

Note: all unused leads must be insulated in accordance with all applicable codes and standards.

Features

- **UL Recognized Component E100887**
- NEMA Type 12 indoor/outdoor enclosure.
- Primary and secondary leads are approximately 18 inches long.
- Consult factory for desired voltage combinations and VA sizes not listed.
- Stainless steel enclosures are also available.
- Electrostatic shield provided on all units.
- Class 1 Div II rated

General Information									
Pri. Volts	240 x 480	600	Dimensions (inches)					Weight (lbs)	
Sec. Volts	120 / 240	120 / 240							
	60 Hz	60 Hz							
kVA Cap.	Catalog Number	Catalog Number	Height A	Width B	Depth C	Mounting			
						D	E		
.500	HL12-1025SH	HL12-5025SH	10.50	10.00	6.62	6.12	4.00	40	
.750	HL12-1030SH	HL12-5030SH	10.50	10.00	6.62	6.12	4.00	42	
1.0	HL12-1035SH	HL12-5035SH	10.50	10.00	6.62	6.12	4.00	45	
1.5	HL12-1040SH	HL12-5040SH	10.50	10.00	6.62	6.12	4.00	50	
2.0	HL12-1045SH	HL12-5045SH	12.00	10.81	7.19	6.69	6.00	75	
3.0	HL12-1050SH	HL12-5050SH	12.00	10.81	7.19	6.69	6.00	80	
5.0	HL12-1055SH	HL12-5055SH	14.00	14.00	9.25	8.75	8.00	140	
7.5	HL12-1060SH	HL12-5060SH	14.00	14.38	10.25	9.75	8.00	205	

DUAL PRIMARY

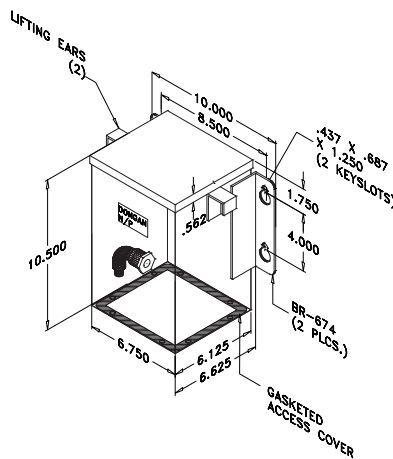
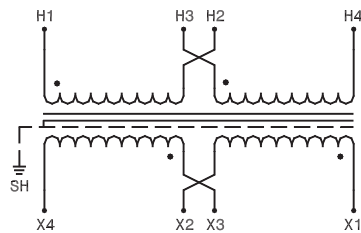

SINGLE PRIMARY

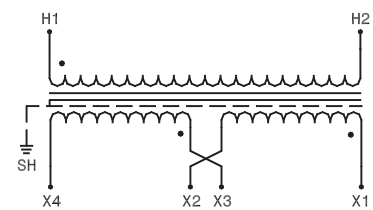

Series HL

Wall Mount - Encapsulated - NEMA 12 - IP54

Dimensions & weights may change. Consult factory for certified drawings.



DONGAN ELECTRIC INTRODUCES OUR NEW PRODUCT OFFERING



Class 2 transformers

The NEC defines a Class 2 circuit as that portion of the wiring system between the load side of a Class 2 power source and the connected equipment. Due to its power limitations, a Class 2 circuit is considered safe from a fire initiation standpoint and provides acceptable protection from electrical shock.. These are typically low-current applications operating at 100VA or less and 30 volts or less. Some Class 2 circuits include air conditioning thermostats, garage door openers and sprinkler system controls. A Class 2 transformer is used to supply Class 2 circuits.



Class 2 transformers have a maximum VA rating of less than 100 VA with most being in the 10-40 VA range. Voltages are a maximum of 240 volts on the primary and these transformers can have multi-tap primary voltages. The secondary is typically 24 volts or less. All

class 2 transformers are limited by either the circuit safety device or their own design.

If a transformer is said to be **inherently** protected that indicates the transformer is designed in such a way as to protect itself and the load without the addition of any fuse. This is accomplished by designing the unit with high impedance. A **non-inherently** protected transformer is protected by an internal fuse or circuit breaker. In the instance of an internal fuse it is a one shot fail fuse, so once the fuse trips, the transformer is rendered inoperable. Smaller class 2 transformers of 50VA or less typically do not have fuses or circuit breakers with the circuit as the transformer is designed to prevent overload by failing before the circuit overheats. In essence the VA determines whether the transformer is inherently or non-inherently protected.

Class 2 Transformer Applications

Class 2 transformers are used in many home and business settings. Common residential items include the power supply on a cordless phone, transformer on a plug-in coffee maker, laptops, the transformer for a plug-in toy and an antenna signal booster. A wall plug is sometimes referred to as a Wall Wort and is another example of a Class 2 transformer found in a business environment might include the power supply for a PBX phone switcher, bakery ovens or external landscape lighting. The market for these is OEM based.

UL

Class 2 transformers must be used in conjunction with Class II circuits. The maximum secondary output cannot exceed 30 alternate current voltage (VAC). The most common combination is 75 VA and 24 VAC. They are regulated by Underwriters Laboratories (UL) guidelines and can be either inherently or non-inherently limited. Dongan sells UL listed Class 2 transformers. However this file is much different that our typical Class 1 transformer file with UL. We must submit each new model for rigorous testing by UL and then that catalog number gets added into our file.

- Commercial Ovens
- Commercial and Industrial Air handling Equipment
- Low voltage lighting
- Irrigation Equipment
- Residential Furnaces
- Residential and Commercial Appliances
- Commercial Laundry Equipment
- Battery Chargers
- Vending Machines
- Espresso Machines
- Ice Cream machines



Outline Drawings

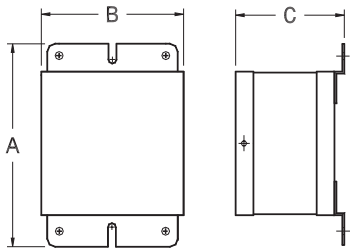

Outline Drawing 1 - Wall Mount

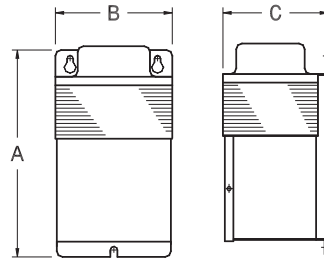

Outline Drawing 2 - Wall Mount

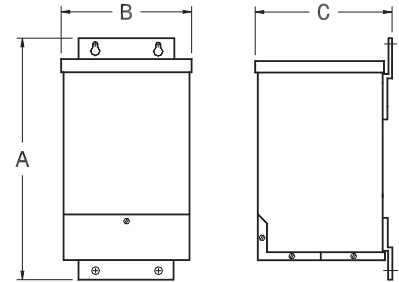

Outline Drawing 3 - Wall Mount

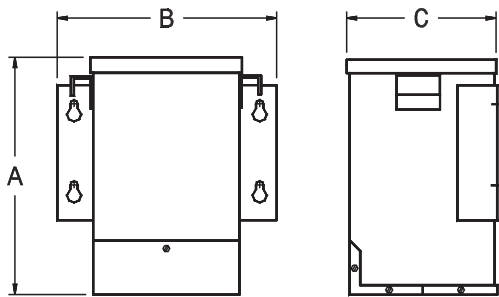

Outline Drawing 4 - Wall Mount

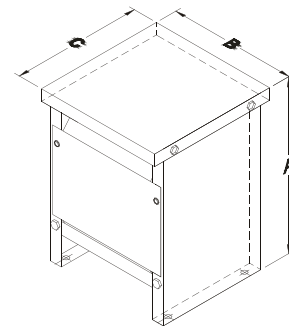

Outline Drawing 5 - Floor Mount

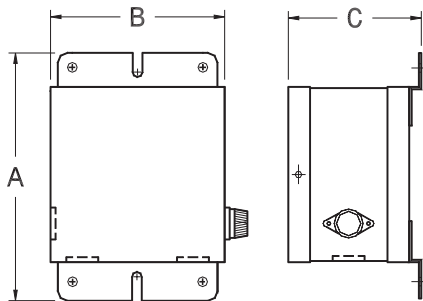

Outline Drawing 6 - Wall Mount

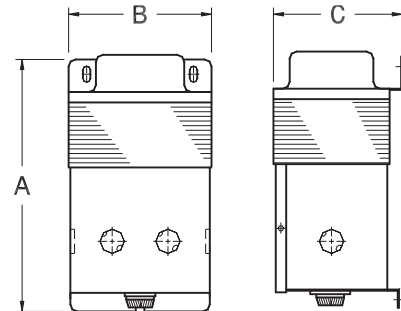

Outline Drawing 7 - Wall Mount

Wall Mounting Brackets - Single Phase 7.5 kVA - 50 kVA

Single Phase
7.5 - 25 kVA
Catalog No.
BR - 890

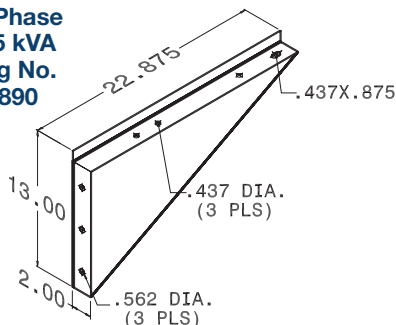

Single Phase
37.5 - 50 kVA
Catalog No.
BR - 892

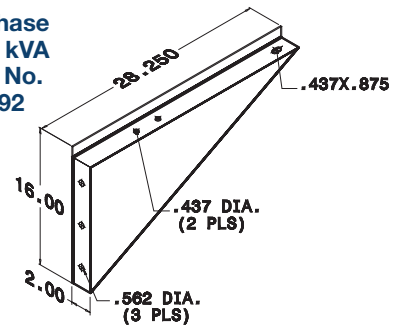

Vanguard - Three Phase - General Purpose

Three Phase: 3 kVA - 9 kVA Epoxy Encapsulated Series 76 ISO-Shield

Features



- Electrostatic shield between primary and secondary windings provides cleaner output voltage and helps to reduce spikes and transients.
- Epoxy-silica encapsulated core
- UL Class 220°C insulation system
- NEMA Type 3R, wall mount enclosure
- Multiple knockouts provide convenient conduit entry and exit locations through the front and bottom access wiring compartment covers.
- Ground studs provided
- Nonstandard designs are available by consulting the factory or your Dongan® representative.



3 - 9 kVA

Three Phase: 15 kVA - 150 kVA Ventilated Series 63 & 73 ISO-Shield

Features



- Electrostatic shield between primary and secondary windings provides cleaner output voltage and helps to reduce spikes and transients.
- Aluminum windings connect to bus bar style terminations equipped with NEMA standard holes for compression style or ring terminals.
- UL Class 220°C insulation system
- NEMA Type 3R, ventilated, cabinet style, floor mount enclosure
- Vibration dampening pads provide quiet operation.
- Wall Mounting brackets are available in sizes up to 75 kVA.
- Ground studs provided
- Nonstandard designs are available by consulting the factory or your Dongan® representative.



15 - 225 kVA

Vanguard - Three Phase - General Purpose

73 Series DOE 2016 Compliant

Primary Volts 480 Delta,
Secondary Volts 240 Delta, 60 Hz
 May be used on a 480Y / 277 Volt Supply

General Information			Winding Specifications				Dimensions			
kVA* Cap.	Catalog Number	Wgt. Lbs	Taps	Maximum Amps		Conn Dia. Pg. 28	Height A	Width B	Depth C	Outline Dwg.
				Pri.	Sec.					
3.0	76-0203SH	140	0	3.6	7.2	2	14.00	16.00	7.75	1
6.0	76-0206SH	212	0	7.2	14.4	2	18.00	20.00	9.50	1
9.0	76-0209SH	265	0	10.8	21.6	2	18.00	20.00	9.50	1
DOE 2016 Compliant										
15.0	73-6215SH*	230	6	18	36	6	23.50	18.88	18.50	2
30.0	73-6230SH*	326	6	36	72	6	29.00	24.25	20.88	2
45.0	73-6245SH*	460	6	54	108	6	29.00	24.25	20.88	2
75.0	73-6275SH*	722	6	90	180	6	32.00	27.25	26.25	2
112.5	73-62112SH*	1001	6	135	270	6	41.00	34.25	26.75	2
150.0	73-62150SH*	1255	6	180	361	6	41.00	34.25	26.75	2

*Transformers 15 kVA through 150 kVA are equipped with a 120 volt lighting tap. Lighting tap capacity is limited to 5% of nameplate rating distributed equally on either side of XO.

Primary Volts 480 Delta,
Secondary Volts 208Y / 120, 60 Hz
 May be used on a 480Y / 277 Volt Supply

General Information			Winding Specifications				Dimensions			
kVA Cap.	Catalog Number	Wgt. Lbs	Taps	Maximum Amps		Conn Dia. Pg. 28	Height A	Width B	Depth C	Outline Dwg.
				Pri.	Sec.					
3.0	76-0303SH	140	0	3.6	8.3	5	14.00	16.00	7.75	1
6.0	76-0306SH	212	0	7.2	16.6	5	18.00	20.00	9.50	1
9.0	76-0309SH	265	0	10.8	25	5	18.00	20.00	9.50	1
DOE 2016 Compliant										
15.0	73-6315SH	230	6	18	41	3	23.50	18.88	18.50	2
30.0	73-6330SH	326	6	36	83	3	29.00	24.25	20.88	2
45.0	73-6345SH	460	6	54	125	3	29.00	24.25	20.88	2
75.0	73-6375SH	722	6	90	208	3	32.00	27.25	26.25	2
112.5	73-63112SH	1001	6	135	312	3	41.00	34.25	26.75	2
150.0	73-63150SH	1255	6	180	416	3	41.00	34.25	26.75	2

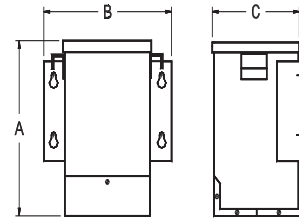

Drawing 1
 3 - 9 kVA
 Wall Mount - Encapsulated - NEMA Type 3R

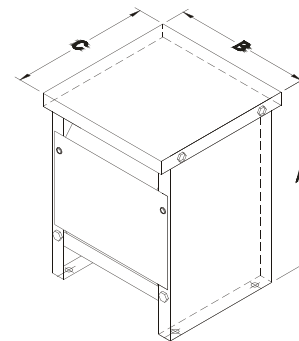

Drawing 2
 15 - 150 kVA
 Floor Mount - Ventilated - NEMA Type 3R

Vanguard - Three Phase - General Purpose

73 Series DOE 2016 Compliant

480 DELTA TO 400Y/230 60HZ

General Information				Winding Specifications				Dimensions			
kVA Cap.	Catalog Number	Hz.	Wgt. Lbs	Taps	Maximum Amps		Conn Dia.	Height A	Width B	Depth C	Outline Dwg.
					Pri.	Sec.					
3	76-3-2601SH	60	140	0	2.9	4.3	See Dia. at Right	6.37	3.75	3.37	1
6	76-6-2601SH	60	212	0	5.8	8.7		7.00	4.00	3.63	2
9	76-9-2601SH	60	265	0	8.7	13		12	4.87	5.25	3
DOE2016 Compliant											
15	73-15-3494SH	60	230	6	36	21.7	See Dia. at Right	23.5	18.88	18.5	2
30	73-30-3494SH	60	326	6	72	43.3		29	24.25	20.88	2
45	73-45-3494SH	60	460	6	108.2	65		29	24.25	20.88	2
75	73-75-3494SH	60	722	6	180.4	108.2		32	27.25	26.25	2
112.5	73-112-3494SH	60	1001	6	270.1	162.4		41	34.25	26.75	2
150	73-150-3494SH	60	1255	6	360.8	216.5		41	34.25	26.75	2
225	73-225-3494SH	60	1500	6	541.2	324.8	44	46	29.75	2	

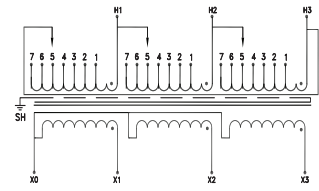

73-XX-3494SH

480 Volt Delta Primary, 480Y/277 Volt Secondary, 60Hz

kVA	Catalog Number	Taps	Mtg. Type W = Wall F = Floor	Conn. Dia.	Height A	Width B	Depth C	Est. Ship Weight (Lbs.)	Wall Brackets (Optional)
15	73-15-512SH	2 - 2 1/2% FCAN 4 - 2 1/2% FCBN	W or F	Consult Factory	23.5	18.8	18.5	260	BR-890
30	73-30-512SH	2 - 2 1/2% FCAN 4 - 2 1/2% FCBN	W or F		29.0	24.3	20.9	420	BR-890
45	73-45-512SH	2 - 2 1/2% FCAN 4 - 2 1/2% FCBN	W or F		29.0	24.3	20.9	480	BR-890
75	73-75-512SH	2 - 2 1/2% FCAN 4 - 2 1/2% FCBN	W or F		32.0	27.3	26.3	690	BR-892
112.5	73-112-512SH	2 - 2 1/2% FCAN 4 - 2 1/2% FCBN	F		41.0	34.3	26.8	960	N.A.
150	73-150-512SH	2 - 2 1/2% FCAN 4 - 2 1/2% FCBN	F		41.0	34.3	26.8	1240	N.A.

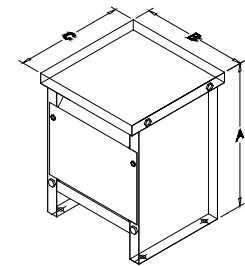

Enclosure Drawing

208 Volt Delta Primary, 480Y/277 Volt Secondary, 60 Hz

kVA	Catalog Number	Taps	Mtg. Type W = Wall F = Floor	Conn. Dia.	Height A	Width B	Depth C	Est. Ship Weight (Lbs.)	Wall Brackets (Optional)
15	73-15-565SH	2 - 2 1/2% FCAN 4 - 2 1/2% FCBN	W or F	Consult Factory	23.5	18.8	18.5	260	BR-890
30	73-30-565SH	2 - 2 1/2% FCAN 4 - 2 1/2% FCBN	W or F		29.0	24.3	20.9	420	BR-890
45	73-45-565SH	2 - 2 1/2% FCAN 4 - 2 1/2% FCBN	W or F		29.0	24.3	20.9	480	BR-890
75	73-75-565SH	2 - 2 1/2% FCAN 4 - 2 1/2% FCBN	W or F		32.0	27.3	26.3	690	BR-892
112.5	73-112-565SH	2 - 2 1/2% FCAN 4 - 2 1/2% FCBN	F		41.0	34.3	26.8	960	N.A.
150	73-150-565SH	2 - 2 1/2% FCAN 4 - 2 1/2% FCBN	F		41.0	34.3	26.8	1240	N.A.

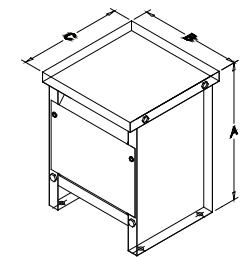

Enclosure Drawing

Vanguard - Three Phase - General Purpose

73 Series DOE 2016 Compliant

240 DELTA TO 400Y/230

General Information				Winding Specifications				Dimensions			
kVA Cap.	Catalog Number	Hz.	Wgt. Lbs	Taps	Maximum Amps		Conn Dia.	Height A	Width B	Depth C	Outline Dwg.
					Pri.	Sec.					
3	76-3-3723SH	60	140	0	7.2	4.3	See Dia. at Right	14	16	7.75	1
6	76-6-3723SH	60	212	0	14.4	8.7		18	20	9.5	1
9	76-9-3723SH	60	265	0	21.7	13		18	20	9.5	1
DOE2016 Compliant											
15	73-15-3934SH	60	230	6	36	21.7	See Dia. at Right	23.5	18.88	18.5	2
30	73-30-3934SH	60	326	6	72	43.3		29	24.25	20.88	2
45	73-45-3934SH	60	460	6	108.2	65		29	24.25	20.88	2
75	73-75-3934SH	60	722	6	180.4	108.2		32	27.25	26.25	2
112.5	73-112-3934SH	60	1001	6	270.1	162.4		41	34.25	26.75	2
150	73-150-3934SH	60	1255	6	360.8	216.5		41	34.25	26.75	2
225	73-225-3934SH	60	1500	6	541.2	324.8		44	46	29.75	2

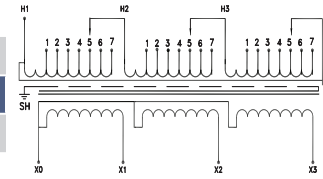

73-XX-3943SH

Primary 240 Delta, Secondary 208Y / 120, 60 Hz

General Information			Winding Specifications				Dimensions			
kVA Cap.	Catalog Number	Wgt. Lbs	Taps	Maximum Amps		Conn Dia. Pg. 29	Height A	Width B	Depth C	Outline Dwg.
				Pri.	Sec.					
3.0	76-0603SH	140	0	7.2	8.3	7	14.00	16.00	7.75	1
6.0	76-0606SH	212	0	14.4	16.6	7	18.00	20.00	9.50	1
9.0	76-0609SH	265	0	21.6	25	7	18.00	20.00	9.50	1
DOE 2016 Compliant										
15	73-6615SH	230	6	36.1	41	8	23.50	18.88	18.5	2
30	73-6630SH	326	6	72	83	8	29.00	24.25	20.88	2
45	73-6645SH	460	6	108	125	8	29.00	24.25	20.88	2
75	73-6675SH	790	6	188.4	208	8	32	27.25	26.25	2

240 Volt Delta Primary, 480Y/277 Volt Secondary, 60 H

kVA	Catalog Number	Taps	Mtg. Type W = Wall F = Floor	Conn. Dia.	Height A	Width B	Depth C	Est. Ship Weight (Lbs.)	Wall Bracketvs (Optional)
15	73-15-2698SH	2 - 2 1/2% FCAN 4 - 2 1/2% FCBN	W or F	Consult Factory	23.5	18.8	18.5	260	BR-890
30	73-30-2698SH	2 - 2 1/2% FCAN 4 - 2 1/2% FCBN	W or F		29.0	24.3	20.9	420	BR-890
45	73-45-2698SH	2 - 2 1/2% FCAN 4 - 2 1/2% FCBN	W or F		29.0	24.3	20.9	480	BR-890
75	73-75-2698SH	2 - 2 1/2% FCAN 4 - 2 1/2% FCBN	W or F		32.0	27.3	26.3	690	BR-892
112.5	73-112-2698SH	2 - 2 1/2% FCAN 4 - 2 1/2% FCBN	F		41.0	34.3	26.8	960	N.A.
150	73-150-2698SH	2 - 2 1/2% FCAN 4 - 2 1/2% FCBN	F	41.0	34.3	26.8	1240	N.A.	

Three Phase - General Purpose

Primary 600 Delta, Secondary 240 Delta, 60 Hz

General Information			Winding Specifications				Dimensions			
kVA* Cap.	Catalog Number	Wgt. Lbs	Taps	Maximum Amps		Conn Dia. Pg. 29	Height A	Width B	Depth C	Outline Dwg.
				Pri.	Sec.					
3.0	76-01003SH	140	0	2.8	7.2	9	14.00	16.00	7.75	1
6.0	76-01006SH	212	0	5.7	14.4	9	18.00	20.00	9.50	1
9.0	76-01009SH	265	0	8.6	21.6	9	18.00	20.00	9.50	1
DOE 2016 Compliant										
15	73-61015SH*	230	6	14.4	36.1	10	23.50	18.88	18.50	2
30	73-61030SH*	326	6	28.9	72	10	29.00	24.25	20.88	2
45	73-61045SH*	460	6	43.3	108	10	29.00	24.25	20.88	2
75	73-61075SH*	722	6	72	180	10	32.00	27.25	26.25	2
112.5	73-610112SH*	1001	6	108	270	10	41.00	34.25	26.75	2
150	73-610150SH*	1255	6	144	361	10	41.00	34.25	26.75	2

*Transformers 15 kVA through 150 kVA are equipped with a 120 volt lighting tap. Lighting tap capacity is limited to 5% of nameplate rating distributed equally on either side of XO.

Primary 600 Delta, Secondary 208Y / 120, 60 Hz

General Information			Winding Specifications				Dimensions			
kVA Cap.	Catalog Number	Wgt. Lbs	Taps	Maximum Amps		Conn Dia. Pg. 29	Height A	Width B	Depth C	Outline No.
				Pri.	Sec.					
3.0	76-0003SH	140	0	2.8	8.3	11	14.00	16.00	7.75	1
6.0	76-0006SH	212	0	5.7	16.6	11	18.00	20.00	9.50	1
9.0	76-0009SH	265	0	8.6	25	11	18.00	20.00	9.50	1
DOE 2016 Compliant										
15	73-6015SH	230	6	14.4	41.6	12	23.50	18.88	18.50	2
30	73-6030SH	326	6	28.9	83	12	29.00	24.25	20.88	2
45	73-6045SH	460	6	43.3	125	12	29.00	24.25	20.88	2
75	73-6075SH	722	6	72	208	12	32.00	27.25	26.25	2
112.5	73-60112SH	1001	6	108	312	12	41.00	34.25	26.75	2
150	73-60150SH	1255	6	144	416	12	41.00	34.25	26.75	2

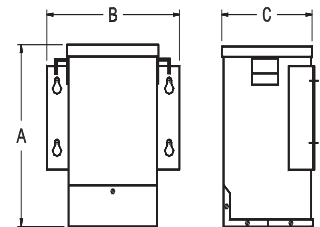

Drawing 1
3 - 9 kVA
Wall Mount - Encapsulated - NEMA
Type 3R

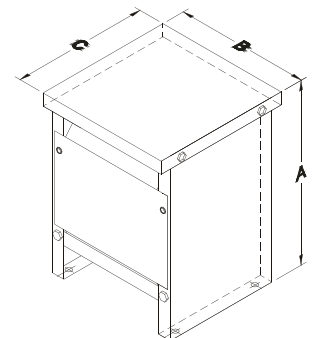

Drawing 2
15 - 150 kVA
Floor Mount - Ventilated - NEMA Type 3R

600 TO 480 60HZ, 480 TO 380 50/60HZ

General Information			Winding Specifications				Dimensions				
kVA Cap.	Catalog Number	Hz.	Wgt. Lbs	Taps	Maximum Amps		Conn Dia.	Height A	Width B	Depth C	Outline Dwg.
					Pri.	Sec.					
15	84-1500-4173E	50/60	104	0	14.4/18	18/22.8	See Dia. at Right	14	12.125	7.75	1
30	84-3000-4173E	50/60	152	0	28.9/36	36/45.6		18	16.125	9.5	1
45	84-4500-4173E	50/60	156	0	43.3/54	54/68.4		18	16.125	9.5	1
75	64-7500-4173	50/60	300	0	72/90.2	90.2/114		23.5	16.875	16	2
112.5	64-11250-4173	50/60	325	0	108.2/135.3	135.3/170.5		29	22.25	18.375	2
150	64-15000-4173	50/60	350	0	144.3/180.4	180.4/228		29	22.25	18.375	2
225	64-22500-4173	50/60	600	0	216.5/270	270/341.9		29	22.25	18.375	2
300	64-30000-4173	50/60	650	0	288.7/360.8	360.8/455.8		29	22.25	18.375	2
375	64-37500-4173	50/60	700	0	360.8/451	451/569.8		29	22.25	18.375	2
500	64-50000-4173	50/60	790	0	481/601	601/759.7		29	22.25	18.375	2

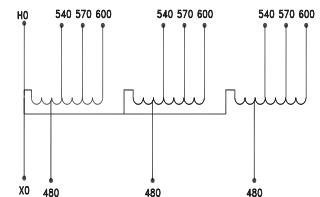

84-XXXX-4173E

Series 76 - Large capacity encapsulated transformers

Series 76 Three Phase Isolation Transformers offer all the advantages of encapsulated transformers - in larger kVA sizes. These transformers are particularly well suited to harsher environments where airborne contaminants may adversely effect ventilated, dry type transformers.

Available in 600 and 480 volt primaries, these transformers feature a 115°C temperature rise, 200°C insulation system, electrostatic shields, and copper windings.

Features



- NEMA Type 3R, indoor / outdoor enclosure.
- Copper wound, 115°C temperature rise.
- Epoxy-silica encapsulated construction.
- NEMA 4X stainless steel available, 304 standard, 316 optional

General Information				Winding Specifications				Dimensions				
kVA Cap.	Pri. 480 Δ	Pri. 480 Δ	Hz.	Taps	Maximum Amps			Wall Mount (WM) Floor Mount (FM)	Height A	Width B	Depth C	Wgt. (lbs)
	Sec. 240	Sec. 208Y/120			Pri. 600 D	Pri. 480 D	Sec. 208Y/120					
	Catalog No.	Catalog No.										
15	76-2215SH	76-2315SH	60	2	14.4	18.0	41.6	WM	18.00	20.00	9.50	220
30	76-2230SH	76-2330SH	60	2	28.9	36.1	83.0	FM	27.50	20.75	19.50	425
45	76-2245SH	76-2345SH	60	2	43.3	54.0	125.0	FM	27.50	20.75	19.50	550
75	76-2275SH*	76-2375SH	60	2	72.0	90.0	208	FM	34.75	34.00	23.00	950

*75 kVA is not UL Listed.

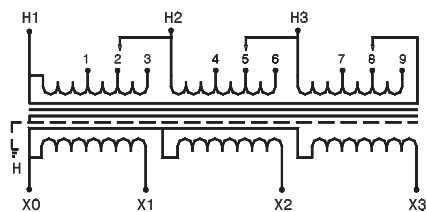

Wiring Diagram - 76 Series

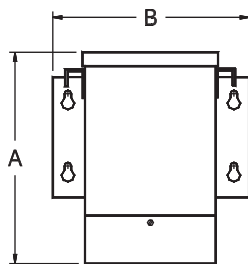

15 kVA
Wall Mount -
Encapsulated - NEMA Type 3R

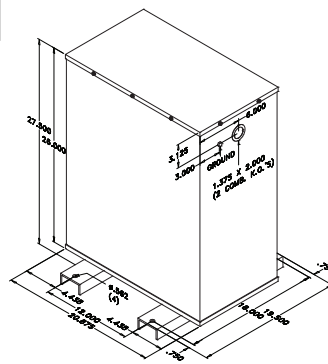

25 - 75 kVA
Floor Mount - Encapsulated - NEMA Type 3R

Three Phase Connection Diagrams

Dia. 1		Catalog Series 63-02XX		
Tap Arrangement: No Taps				
% High Voltage	High Voltage	Inter-Connect	Connect High Voltage Lines To	
100	480		H1 & H2 & H3	
% Low Voltage	Low Voltage	Inter-Connect	Connect Low Voltage Lines To	
100	240		X1 & X2 & X3	

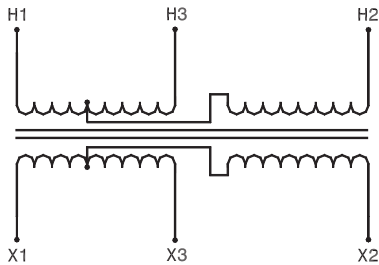

Dia. 2		Catalog Series 76-02XXSH		
Tap Arrangement: No Taps				
% High Voltage	High Voltage	Inter-Connect	Connect High Voltage Lines To	
100	480		H1 & H2 & H3	
% Low Voltage	Low Voltage	Inter-Connect	Connect Low Voltage Lines To	
100	240		X1 & X2 & X3	

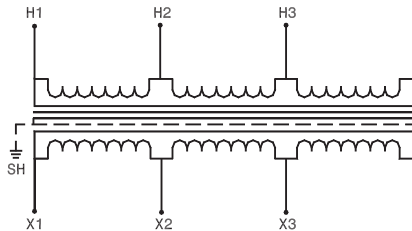

Dia. 3		Catalog Series 73-63XXSH		
Tap Arrangement: 2 - 2½ FCAN (Full Capacity Above Normal) 4 - 2½ FCBN (Full Capacity Below Normal)				
% High Voltage	High Voltage	Inter-Connect	Connect High Voltage Lines To	
90	432	1		
92.5	444	2		
95	456	3		
97.5	468	4	H1-H2-H3	
100	480	5		
102.5	492	6		
105	504	7		
% Low Voltage	Low Voltage	Inter-Connect	Connect Low Voltage Lines To	
100	240		X1 & X2 & X3	
100	120*		X2 to X0 or X3 to X0	

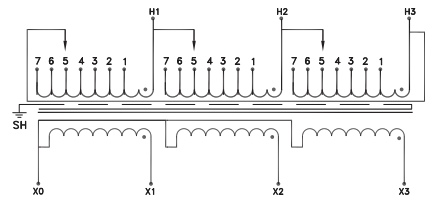

*Lighting tap capacity is limited to 5% of nameplate rating distributed equally on either side of X0.

Dia. 4		Catalog Series 63-03XX		
Tap Arrangement: No Taps				
% High Voltage	High Voltage	Inter-Connect	Connect High Voltage Lines To	
100	480		H1 & H2 & H3	
% Low Voltage	Low Voltage	Inter-Connect	Connect Low Voltage Lines To	
100	208Y / 120		X1 & X2 & X3	
100	120		X1 to X0 X2 to X0 X3 to X0	

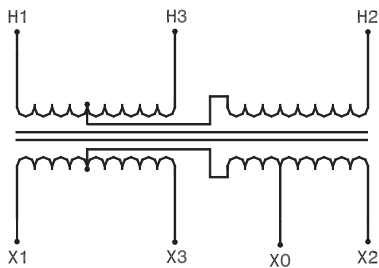

Dia. 5		Catalog Series 76-03XXSH		
Tap Arrangement: No Taps				
% High Voltage	High Voltage	Inter-Connect	Connect High Voltage Lines To	
100	480		H1 & H2 & H3	
% Low Voltage	Low Voltage	Inter-Connect	Connect Low Voltage Lines To	
100	208Y / 120		X1 & X2 & X3	
100	120		X1 to X0 X2 to X0 X3 to X0	

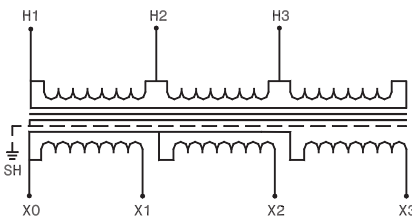

Dia. 6		Catalog Series 73-62XXSH		
Tap Arrangement: 2 - 2½ FCAN (Full Capacity Above Normal) 4 - 2½ FCBN (Full Capacity Below Normal)				
% High Voltage	High Voltage	Inter-Connect	Connect High Voltage Lines To	
90	432	1		
92.5	444	2		
95	456	3		
97.5	468	4	H1-H2-H3	
100	480	5		
102.5	492	6		
105	504	7		
% Low Voltage	Low Voltage	Inter-Connect	Connect Low Voltage Lines To	
100	208		X1 & X2 & X3	
100	120		X1 to X0 X2 to X0 X3 to X0	

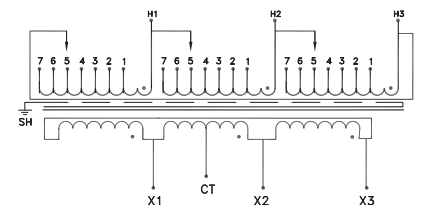

Three Phase Connection Diagrams

Dia. 7		Catalog Series 76-06XXSH	
Tap Arrangement		No Taps	
% High Voltage	High Voltage	Inter-Connect	Connect High Voltage Lines To
100	240		H1 & H2 & H3
% Low Voltage	Low Voltage	Inter-Connect	Connect Low Voltage Lines To
100	208		X1 & X2 & X3
100	120		X1 to X0 X2 to X0 X3 to X0

Dia. 8		Catalog Series 73-66XXSH	
Tap Arrangement		2 - 2½ FCAN (Full Capacity Above Normal) 4 - 2½ FCBN (Full Capacity Below Normal)	
% High Voltage	High Voltage	Inter-Connect	Connect High Voltage Lines To
90	216	1	
92.5	222	2	
95	228	3	
97.5	234	4	H1-H2-H3
100	240	5	
102.5	246	6	
105	252	7	
% Low Voltage	Low Voltage	Inter-Connect	Connect Low Voltage Lines To
100	208		X1 & X2 & X3
100	120		X1 to X0 X2 to X0 X3 to X0

Dia. 9		Catalog Series 76-01XXSH	
Tap Arrangement		No Taps	
% High Voltage	High Voltage	Inter-Connect	Connect High Voltage Lines To
100	600	--	H1 & H2 & H3
% Low Voltage	Low Voltage	Inter-Connect	Connect Low Voltage Lines To
100	240		X1 & X2 & X3

Dia. 10		Catalog Series 73-61XXSH	
Tap Arrangement		2 - 2½ FCAN (Full Capacity Above Normal) 4 - 2½ FCBN (Full Capacity Below Normal)	
% High Voltage	High Voltage	Inter-Connect	Connect High Voltage Lines To
90	540	1	
92.5	555	2	
95	570	3	
97.5	585	4	H1-H2-H3
100	600	5	
102.5	615	6	
105	630	7	
% Low Voltage	Low Voltage	Inter-Connect	Connect Low Voltage Lines To
100	240		X1 & X2 & X3
100	120*		X2, X0 or X3, X0

Dia. 11		Catalog Series 76-00XXSH	
Tap Arrangement		No Taps	
% High Voltage	High Voltage	Inter-Connect	Connect High Voltage Lines To
100	600		H1 & H2 & H3
% Low Voltage	Low Voltage	Inter-Connect	Connect Low Voltage Lines To
100	208		X1 & X2 & X3
100	120		X1 to X0 X2 to X0 X3 to X0

Dia. 12		Catalog Series 73-60XXSH	
Tap Arrangement		2 - 2½ FCAN (Full Capacity Above Normal) 4 - 2½ FCBN (Full Capacity Below Normal)	
% High Voltage	High Voltage	Inter-Connect	Connect High Voltage Lines To
90	540	1	
92.5	555	2	
95	570	3	
97.5	585	4	H1-H2-H3
100	600	5	
102.5	615	6	
105	630	7	
% Low Voltage	Low Voltage	Inter-Connect	Connect Low Voltage Lines To
100	208		X1 & X2 & X3
100	120		X1 to X0 X2 to X0 X3 to X0

*Lighting tap capacity is limited to 5% of nameplate rating distributed equally on either side of X0.

Three Phase Transformers

Series ES-31 CE Marked

Series ES Three Phase Encapsulated Transformers are designed to comply with Domestic, North American, and European Union electrical and testing standards. Series ES are UL and Canadian UL Listed by Underwriters Labs. In addition, Series ES are CE Marked, and licensed by the German testing agency TÜV Rheinland.

Series ES transformers are the answer to your export needs. With the voltage combinations listed below, and built in approvals, the ES Series provide no-nonsense solutions for equipment destined for the European Community of nations.

Agency Compliance



Features

- NEMA Type 12, IP54 enclosure.
- IP23 also available
- Epoxy Encapsulated.
- IEC type finger safe terminals.
- 220°C Insulation System.
- 50/60 Hz.
- All Series ES are provided with an electrostatic shield.
- All Series ES are provided with a color coded protective earth (PE) terminal.
- NEMA 3R available

General Information									
Pri. Volts	380 Delta	416 Delta	Dimensions (inches)						Weight (lbs)
Sec. Volts	240 / 120 Delta Center - Tapped	240 / 120 Delta Center - Tapped	A	B	C	Mounting			
kVA Cap.	Catalog Number	Catalog Number	A	B	C	D	E	F	Weight (lbs)
1	ES-31200.542	ES-31200.552	15.00	18.00	12.50	12.00	8.00	16.00	170
3	ES-31250.542	ES-31250.552	15.00	18.00	12.50	12.00	8.00	16.00	180
6	ES-31310.542	ES-31310.552	15.00	18.00	12.50	12.00	8.00	16.00	200
10	ES-31360.542	ES-31360.552	18.00	21.00	10.50	10.00	8.00	19.00	295
15	ES-31380.542	ES-31380.552	18.00	21.00	10.50	10.00	8.00	19.00	315
20	ES-31390.542	ES-31390.552	27.50	24.75	12.25	12.00	5.00	23.25	430
25	ES-31410.542	ES-31410.552	27.50	24.75	12.25	12.00	5.00	23.25	450
30	ES-31420.542	ES-31420.552	27.50	24.75	12.25	12.00	5.00	23.25	500
40	ES-31450.542	ES-31450.552	27.50	24.75	16.25	16.00	9.00	23.25	535

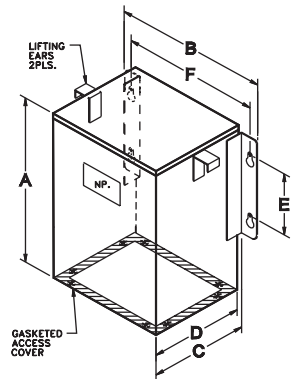

1 - 15 kVA
Wall Mount - Encapsulated -
NEMA Type 12 - IP54

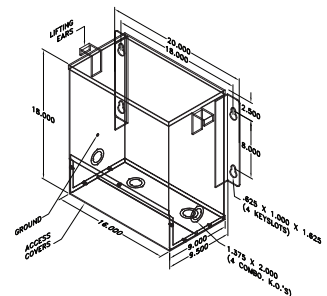
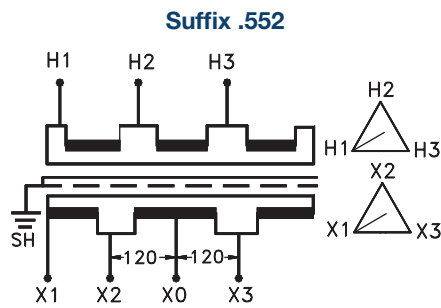
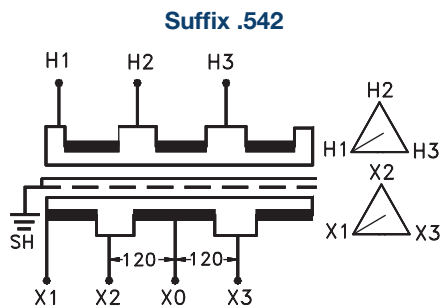

20 - 40 kVA
Floor Mount - Encapsulated -
NEMA Type 12 - IP54

Primary Connections		Secondary Connections	
Pri. Voltage	Connect Incoming Lines To:	Sec. Voltage	Connect Load Lines To:
380 Delta, 3 Phase	H1, H2, H3	240 Delta, 3 Phase	X1, X2, X3
		120 1 Phase*	X0 & X2 X0 & X3

Primary Connections		Secondary Connections	
Pri. Voltage	Connect Incoming Lines To:	Sec. Voltage	Connect Load Lines To:
416 Delta, 3 Phase	H1, H2, H3	240 Delta, 3 Phase	X1, X2, X3
		120 1 Phase*	X0 & X2 X0 & X3

Motor Drive Isolation Transformers

Dongan® Motor Drive Isolation Transformers are specifically designed to meet the requirements of SCR controlled variable speed motor drives. They are ruggedly constructed to withstand the high mechanical forces associated with SCR drive duty cycles. The double-wound construction isolates the line from most SCR generated voltage spikes and transient feedback. These transformers also assist in reducing some types of line transients that can cause SCR misfiring.

enclosure. No extra rainshields required for outdoor use.

- **11 - 145 kVA are aluminum wound and equipped with a UL 220°C insulation system.**

Features



- **Three Phase 3 - 145 kVA.**
- **Electrostatic shield between windings.**
- **Vibration dampening pads provide quiet operation.**
- **Wall Mounting brackets are available for sizes 11 kVA through 75 kVA (see page 29).**
- **Ground studs provided.**
- **Core and coil and nonstandard designs are available by consulting the factory or your Dongan® Representative.**
- **NEMA Type 3R, ventilated, wall mount**



11 - 145 kVA

General Information									
Delta Pri.		230	230	460	460	575	575	Taps	Weight (lbs)
Wye Sec.		230Y/133	460Y/266	230Y/133	460Y/266	230Y/133	460Y/266		
kVA Cap.	Motor HP	Catalog Number	Catalog Number	Catalog Number	Catalog Number	Catalog Number	Catalog Number		
3	2	63-0103SH	63-0403SH	63-0503SH	63-0703SH	63-0803SH	63-0903SH	0	70
6	3	63-0106SH	63-0406SH	63-0506SH	63-0706SH	63-0806SH	63-0906SH	0	136
7.5	5	63-0107SH	63-0407SH	63-0507SH	63-0707SH	63-0807SH	63-0907SH	0	185
11	7.5	63-2111SH	63-2411SH	63-2511SH	63-2711SH	63-2811SH	63-2911SH	2	225
14	10	63-2114SH	63-2414SH	63-2514SH	63-2714SH	63-2814SH	63-2914SH	2	245
20	15	63-2120SH	63-2420SH	63-2520SH	63-2720SH	63-2820SH	63-2920SH	2	275
27	20	63-2127SH	63-2427SH	63-2527SH	63-2727SH	63-2827SH	63-2927SH	2	290
34	25	63-2134SH	63-2434SH	63-2534SH	63-2734SH	63-2834SH	63-2934SH	2	415
40	30	63-2140SH	63-2440SH	63-2540SH	63-2740SH	63-2840SH	63-2940SH	2	440
51	40	63-2151SH	63-2451SH	63-2551SH	63-2751SH	63-2851SH	63-2951SH	2	500
63	50	63-2163SH	63-2463SH	63-2563SH	63-2763SH	63-2863SH	63-2963SH	2	560
75	60	63-2175SH	63-2475SH	63-2575SH	63-2775SH	63-2875SH	63-2975SH	2	580
93	75	63-2193SH	63-2493SH	63-2593SH	63-2793SH	63-2893SH	63-2993SH	2	1000
118	100	63-21118SH	63-24118SH	63-25118SH	63-27118SH	63-28118SH	63-29118SH	2	1100
145	125	63-21145SH	63-24145SH	63-25145SH	63-27145SH	63-28145SH	63-29145SH	2	1200

Motor Drive transformers are exempt from the US DOE TP1 requirements. However they do not meet Canadian C802.22 energy requirements. If this is required you must order a 43- catalog number.

Motor Drive Isolation Transformers

Dimensions										
kVA	Motor HP	Physical			Mounting				Taps	Dwg. No.
		Height A	Width B	Depth C	D	E	F	Mtg Type*		
3	2	11.50	15.50	7.75	6.31	14.00	0.437	WM	0	1
6	3	14.00	18.50	9.00	8.50	17.00	0.437	WM	0	1
7.5	5	17.50	17.00	10.00	11.50	15.50	0.562	WM	0	1
11	7.5	23.50	18.87	18.50	13.00	16.87	0.437	FM	2	2
14	10	23.50	18.87	18.50	13.00	16.87	0.437	FM	2	2
20	15	29.00	24.25	20.87	15.37	22.25	0.437	FM	2	2
27	20	29.00	24.25	20.87	15.37	22.25	0.437	FM	2	2
34	25	29.00	24.25	20.87	15.37	22.25	0.437	FM	2	2
40	30	29.00	24.25	20.87	15.37	22.25	0.437	FM	2	2
51	40	32.00	27.25	26.25	20.75	25.25	0.562	FM	2	2
63	50	32.00	27.25	26.25	20.75	25.25	0.562	FM	2	2
75	60	32.00	27.25	26.25	20.75	25.25	0.562	FM	2	2
93	75	41.00	34.25	26.75	21.25	32.25	0.562	FM	2	2
118	100	41.00	34.25	26.75	21.25	32.25	0.562	FM	2	2
145	125	41.00	34.25	26.75	21.25	32.25	0.562	FM	2	2

*WM = WALL MOUNT FM = FLOOR MOUNT

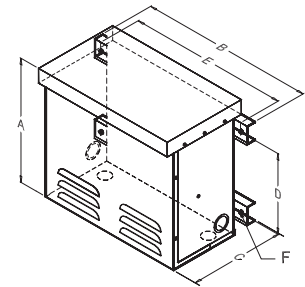

Drawing 1
3 - 7.5 kVA
Wall Mount - Ventilated - NEMA Type 3R

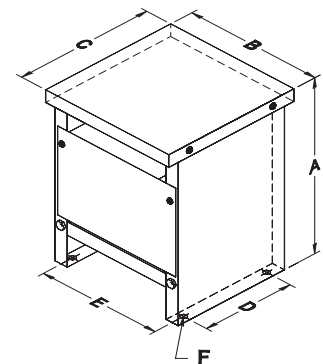

Drawing 2
11 - 145 kVA
Floor Mount - Ventilated - NEMA Type 3R

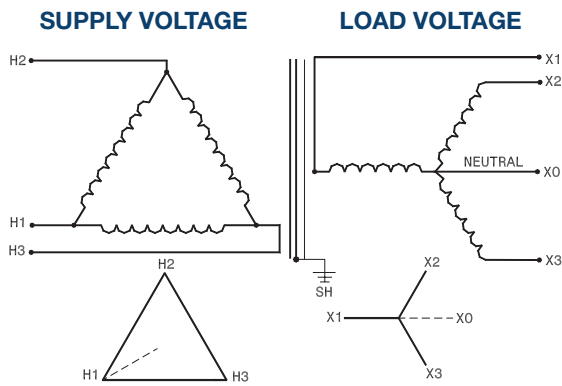

Diagram 1 (3 - 7.5 kVA)

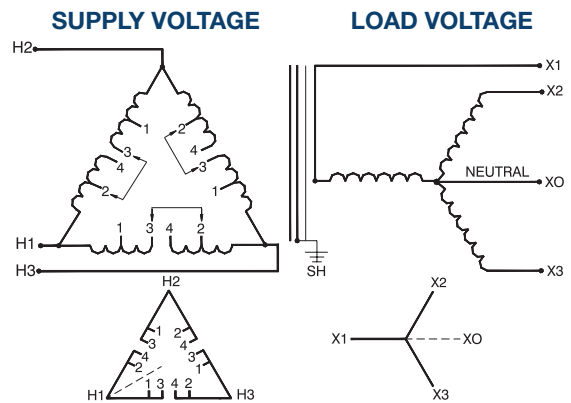

Diagram 2 (11 - 145 kVA)

K-Factor Transformers for Harmonic Loads

Domestic distribution systems and linear loads operate at the fundamental frequency of 60 Hz. Harmonic content in distribution systems means that there are integer multipliers of the fundamental 60 Hz frequency present. For instance, the second harmonic is 120 Hz, the third harmonic is 180 Hz, the fourth harmonic is 240 Hz, etc.

Dongan® K-Factor transformers are specifically engineered to operate at full load and full harmonic

rating without exceeding the rated insulation system values - effectively neutralizing the dangerous effects of temperature and circulating currents. Windings and cores are designed to operate in the presence of triplen harmonics without overheating or forcing the core into saturation. These transformers will provide years of trouble free service to large office buildings, industrial plants, processing equipment and any load with a designated harmonic content.

Series LTF & LTH - Low temperature rise, 80°C and 115°C

Series LTF and LTH Transformers are three phase, low temperature rise, air cooled, general purpose distribution transformers. These transformers feature either an 80°C temperature rise or a 115°C temperature rise with a 220°C insulation system and all are shielded. They are designed for applications where cool operating temperatures or thermal overload requirements are demanded.

Features



- NEMA Type 3R, indoor / outdoor enclosure.
- 80°C and 115°C temperature rise units.
- 220°C Insulation system.
- Featuring three phase, 480 volt Delta primary windings with a secondary winding of 208Y/120.

Three Phase - Specialty Applications

Three Phase Open Delta Autotransformer Connections

Single phase, general purpose transformers may be used to achieve a wide variety of nonstandard voltage combinations. These combinations are achieved by connecting two identical, 240/480 volt primary, 120

x 240 volt secondary, single phase transformers into three phase, autotransformer banks - much like the buck-boost configurations featured on pages 48 - 66 later in this catalog.

General Information			Pri. Volts - 600 Sec. Volts - 480			
kVA Cap.	Catalog Number	Qty. Req'd	Maximum Amps		Bank KVA	Conn. Dia. No.
			600	480		
.500	85-1025SH*	2	4.2	5.2	4.3	Dia-2038
.750	85-1030SH*	2	6.3	7.8	6.5	Dia-2038
1	85-1035SH*	2	8.3	10.4	8.6	Dia-2038
1.5	85-1040SH*	2	12.5	15.6	13.0	Dia-2038
2	85-1045SH*	2	16.6	20.8	17.3	Dia-2038
3	85-1050SH*	2	25	31	25.9	Dia-2038
5	85-1055SH*	2	41	52	43.2	Dia-2038
7.5	85-1060SH*	2	62	78	64.8	Dia-2038
10	61-1465SH	2	83	104	86.4	Dia-2039
15	41-1470SH	2	125	156	129	Dia-2039
25	41-1475SH	2	208	260	216	Dia-2039
37.5	41-1680SH	2	312	390	325	Dia-2040
50	41-1685SH	2	416	520	432	Dia-2040
75	41-1690SH	2	625	780	650	Dia-2040
100	41-1695SH	2	832	1040	865	Dia-2040

General Information			Pri. Volts - 480 Sec. Volts - 240			
kVA Cap.	Catalog Number	Qty. Req'd	Maximum Amps		Bank KVA	Conn. Dia. No.
			480	240		
.500	85-1025SH*	2	2.0	4.0	1.7	Dia-3080
.750	85-1030SH*	2	3.1	6.2	2.6	Dia-3080
1	85-1035SH*	2	4.1	8.2	3.4	Dia-3080
1.5	85-1040SH*	2	6.2	12.4	5.1	Dia-3080
2	85-1045SH*	2	8.2	16.4	6.8	Dia-3080
3	85-1050SH*	2	12	24	10	Dia-3080
5	85-1055SH*	2	20	40	17	Dia-3080
7.5	85-1060SH*	2	31	62	26	Dia-3080
10	61-1465SH	2	41	82	34	Dia-3081
15	41-1470SH	2	62	124	51	Dia-3081
25	41-1475SH	2	102	204	85	Dia-3081
37.5	41-1680SH	2	153	306	128	Dia-3082
50	41-1685SH	2	205	410	170	Dia-3082
75	41-1690SH	2	310	620	258	Dia-3082
100	41-1695SH	2	415	830	344	Dia-3082

Three Phase - Specialty Applications

Series ODY - Factory Pre-Connected Autotransformers

Series ODY Autotransformers offer a fast, economical, factory pre-connected installation for transforming three phase lines from 208 to 240, or from 240 to 208. Simply bring in three wires on the line side and

take out three wires on the load side. Series ODY offer an economical method of bucking and boosting 208 and 240 volt lines where the presence of a fourth wire neutral is not needed.

General Information				Winding Specifications				Dimensions		
kVA Cap.	Catalog Number	Hz.	Wgt. Lbs	Taps	Maximum Amps		Conn Dia.	Height A	Width B	Depth C
					208	240				
2.8	84-280-ODY	60	21	0	7.8	6.7	ODY	9.75	4.63	4.06
5.6	84-560-ODY	60	37	0	15.6	13.5	ODY	12.25	5.31	4.75
8.4	84-840-ODY	60	54	0	23.4	20.2	ODY	15.50	5.31	4.75
11.2	84-1120-ODY	60	55	0	31.2	27.0	ODY	15.50	5.31	4.75
16.9	84-1690-ODY	60	65	0	46.8	40.5	ODY	16.13	7.19	5.81
22.5	84-2250-ODY	60	74	0	62.4	54.1	ODY	17.13	7.19	5.81
33.0	84-3300-ODY	60	127	0	93.6	81.1	ODY	20.50	7.69	6.75
56.0	84-5600-ODY	60	158	0	156.1	135.3	ODY	24.88	7.69	6.75

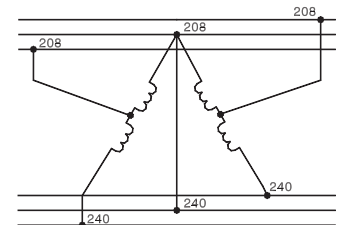

Wiring Diagram - ODY

Series 3PTT

Series 3PTT Three Phase Auto Testing Transformers allow three phase line voltages to be transformed into various three phase voltages found around the world. Voltages include 208, 220, 240, 380, 440, 480, 550, and avv volts three phase. All taps are designed to carry full load current at rated voltage. All 3PTT Series transformers are copper wound.



General Information				Winding Specifications								Dimensions				
kVA Cap.	Catalog Number	Hz.	Wgt. Lbs	Taps	Maximum Amps								Conn Dia.	Height A	Width B	Depth C
					208	220	240	380	440	480	550	600				
5	84-500-3PTT	50/60	70	0	13	13	12	7	6	6	5	4	3PTT	11.50	15.50	7.75
10	84-1000-3PTT	50/60	150	0	27	26	24	15	13	12	10	9	3PTT	21.88	25.00	18.13
15	84-1500-3PTT	50/60	180	0	41	39	36	22	19	18	15	14	3PTT	21.88	25.00	15.12
25	84-2500-3PTT	50/60	350	0	69	65	60	38	32	30	26	24	3PTT	21.88	25.00	15.12
37	84-3750-3PTT	50/60	430	0	104	98	90	57	49	45	39	36	3PTT	21.88	25.00	15.12
50	84-5000-3PTT	50/60	550	0	138	131	120	76	65	60	52	48	3PTT	29.00	24.25	20.88
75	84-7500-3PTT	50/60	650	0	208	197	180	114	98	90	78	72	3PTT	32.00	27.25	26.25
100	84-10000-3PTT	50/60	780	0	277	262	240	152	131	120	105	96	3PTT	32.00	27.25	26.25

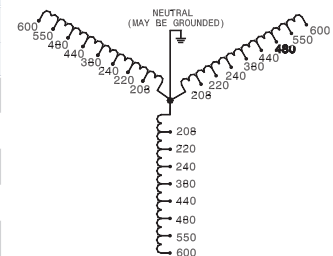

Wiring Diagram - 3PTT

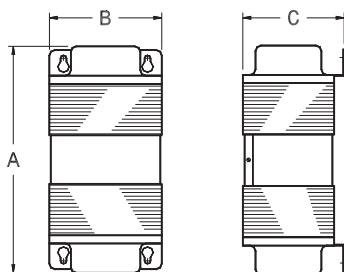

Series ODY
Wall Mount - Ventilated - NEMA Type 3R

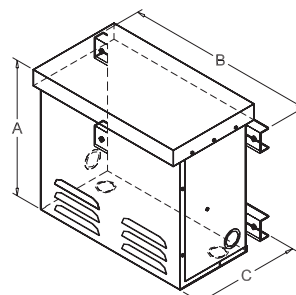

Series 3PTT, 5 - 37 kVA
Wall Mount - Ventilated - NEMA Type 3R

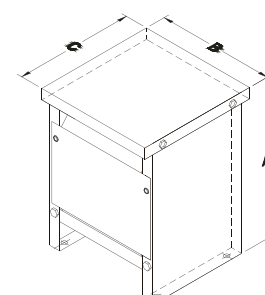

Series 3PTT, 50 - 100 kVA
Floor Mount - Ventilated - NEMA Type 3R

Dimensions & weights may change. Consult factory for certified drawings.

Three Phase Outline Drawings

Outline Drawings

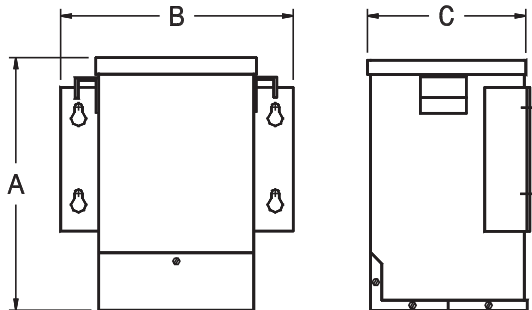

Outline Drawing 1 - Wall Mount

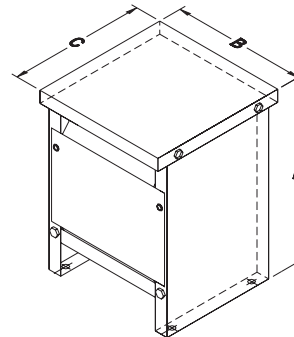

Outline Drawing 2 - Floor Mount

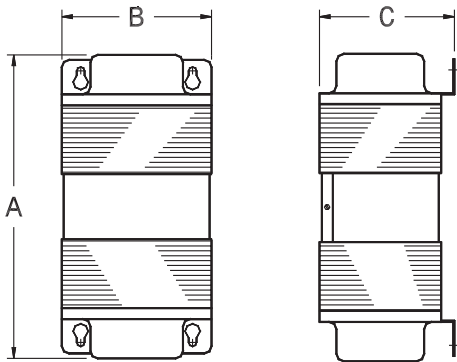

Outline Drawing 3 - Wall Mount

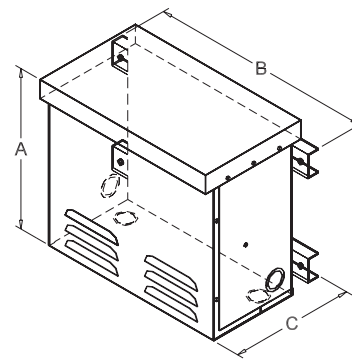

Outline Drawing 4 - Wall Mount

Wall Mounting Brackets - Three Phase 15 kVA - 75 kVA

Three Phase
15 kVA - 45 kVA
Catalog No.
BR - 890

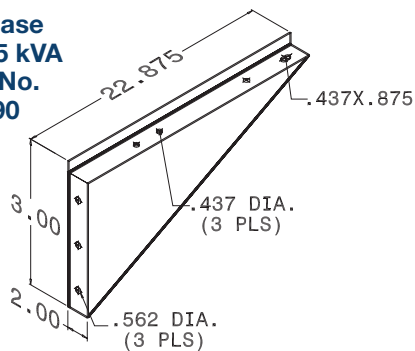

Three Phase
75 kVA
Catalog No.
BR - 892

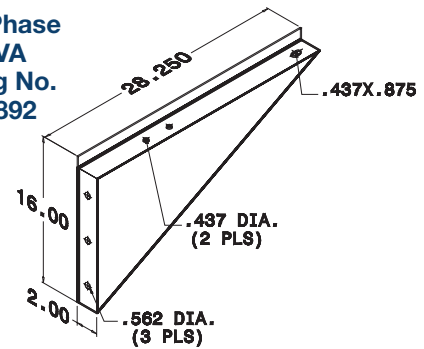

Single Phase Buck-Boost Sizing Tables

Single Phase Buck-Boost Table, Type M

Type M		Single Phase / Single Unit - Type M												
		Boost - Increase Voltage								Buck - Decrease Voltage				
Catalog Number	Line	96	100	108	109	216	218	228	208	132	144	230	252	264
	Load	120	120	120	120	240	240	240	230	120	120	208	240	240
35-M005	Load Amps	2.0	2.0	3.7	4.1	2.0	2.0	4.1	1.9	4.5	2.5	2.1	4.3	2.2
	kVA	0.25	0.25	0.45	0.49	0.50	0.49	1.00	0.45	0.55	0.30	0.45	1.05	0.55
	Line Fuse	5	5	8	8	5	5	7	5	7	5	5	7	5
35-M010	Load Amps	4.1	4.1	7.5	8.2	4.1	4.1	8.3	3.9	9.1	5.0	4.3	8.7	4.5
	kVA	0.50	0.50	0.90	0.99	1.00	0.99	2.00	0.90	1.10	0.60	0.91	2.10	1.10
	Line Fuse	10	10	15	15	8	8	15	8	15	7	7	15	7
35-M015	Load Amps	6.2	6.2	11.2	12.3	6.2	6.1	12.5	5.9	13.7	7.5	6.5	13.1	6.8
	kVA	0.75	0.75	1.35	1.48	1.50	1.48	3.00	1.36	1.65	0.90	1.36	3.15	1.65
	Line Fuse	15	15	20	20	12	12	20	12	20	12	10	20	12
85-M020	Load Amps	10.4	10.4	18.7	20.6	10.4	10.3	20.8	9.8	22.9	12.5	10.9	21.8	11.4
	kVA	1.25	1.25	2.25	2.47	2.50	2.47	5.00	2.26	2.75	1.50	2.27	5.25	2.75
	Line Fuse	20	20	30	30	15	15	30	15	30	15	15	30	15
85-M025	Load Amps	20.8	20.8	37.5	41.2	20.8	20.6	41.6	19.7	45.8	25.0	21.8	43.7	22.9
	kVA	2.50	2.50	4.50	4.95	5.00	4.95	10.00	4.53	5.50	3.00	4.55	10.50	5.50
	Line Fuse	35	35	60	60	30	30	60	30	60	30	30	60	30
85-M030	Load Amps	31.2	31.2	56.2	61.9	31.2	30.9	62.5	29.5	68.7	37.5	32.8	65.6	34.3
	kVA	3.75	3.75	6.75	7.43	7.50	7.43	15.00	6.79	8.25	4.50	6.83	15.75	8.25
	Line Fuse	50	50	80	90	45	45	80	45	80	40	40	80	40
85-M035	Load Amps	41.6	41.6	75.0	82.5	41.6	41.2	83.3	39.4	91.6	50.0	43.7	87.5	45.8
	kVA	5.00	5.00	9.00	9.90	10.00	9.90	20.00	9.06	11.00	6.00	9.10	21.00	11.00
	Line Fuse	70	70	125	125	60	60	110	60	110	60	60	110	60
85-M040	Load Amps	62.5	62.5	112.5	123.8	62.5	61.9	125.0	59.1	137.5	75.0	65.6	131.2	68.7
	kVA	7.5	7.5	13.5	14.8	15.0	14.8	30.0	13.5	16.5	9.0	13.6	31.5	16.5
	Line Fuse	100	100	175	175	80	80	175	90	175	80	80	175	80
85-M045	Load Amps	83.3	83.3	150.0	165.1	83.3	82.5	166.6	78.8	183.3	100.0	87.5	175.0	91.6
	kVA	10.0	10.0	18.0	19.8	20.0	19.8	40.0	18.1	22.0	12.0	18.2	42.0	22.0
	Line Fuse	150	150	250	250	125	125	225	125	225	110	110	225	110
85-M050	Load Amps	125.0	125.0	225.0	247.7	125.0	123.8	250.0	118.2	275.0	150.0	131.3	262.5	137.5
	kVA	15.0	15.0	27.0	29.7	30.0	29.7	60.0	27.1	33.0	18.0	27.3	63.0	33.0
	Line Fuse	200	200	350	350	175	175	350	175	350	175	150	350	175
85-M055	Load Amps	208.3	208.3	375.0	412.8	208.3	206.4	416.6	197.0	458.3	250.0	218.9	437.5	229.1
	kVA	25.0	25.0	45.0	49.5	50.0	49.5	100.0	45.3	55.0	30.0	45.5	105.0	55.0
	Line Fuse	350	350	600	600	300	300	600	300	600	300	250	600	300
Qty. Required		1	1	1	1	1	1	1	1	1	1	1	1	1
Connection Dia. Page		SP - 8 43	SP - 12 44	SP - 7 43	SP - 11 44	SP - 6 43	SP - 10 44	SP - 5 43	SP - 10 44	SP - 3 43	SP - 4 43	SP - 2 43	SP - 1 43	SP - 2 43

Single Phase Buck-Boost Sizing Tables

Single Phase Buck-Boost Table, Type Y

Type Y		Single Phase / Single Unit - Type Y												
		Boost - Increase Voltage								Buck - Decrease Voltage				
Catalog Number	Line	88	95	104	106	212	224	225	208	136	152	256	272	240
	Load	120	120	120	120	240	240	240	240	120	120	240	240	208
35-Y005	Load Amps	1.5	1.9	3.1	3.1	1.5	3.1	3.1	1.5	3.5	1.9	3.3	1.7	1.8
	kVA	0.18	0.23	0.37	0.37	0.37	0.75	0.75	0.37	0.42	0.23	0.80	0.42	0.37
	Line Fuse	5	5	5	5	5	5	5	5	5	5	5	5	5
35-Y010	Load Amps	3.1	3.9	6.2	6.3	3.1	6.2	6.2	3.1	7.0	3.9	6.6	3.5	3.6
	kVA	0.37	0.47	0.75	0.75	0.75	1.50	1.50	0.75	0.85	0.47	1.60	0.85	0.75
	Line Fuse	7	8	12	12	6	10	10	6	10	5	10	5	5
35-Y015	Load Amps	4.6	5.9	9.3	9.4	4.7	9.3	9.3	4.6	10.6	5.9	10.0	5.3	5.4
	kVA	0.56	0.71	1.12	1.13	1.13	2.25	2.25	1.12	1.27	0.71	2.40	1.27	1.12
	Line Fuse	10	15	15	15	9	15	15	9	15	8	15	8	8
85-Y020	Load Amps	7.8	9.8	15.6	15.7	7.8	15.6	15.6	7.8	17.7	9.8	16.6	8.8	9.0
	kVA	0.93	1.18	1.87	1.89	1.89	3.75	3.75	1.87	2.12	1.18	4.00	2.12	1.87
	Line Fuse	15	25	25	25	15	25	25	15	20	15	20	15	15
85-Y025	Load Amps	15.6	19.7	31.2	31.5	15.7	31.2	31.2	15.6	35.4	19.7	33.3	17.7	18.0
	kVA	1.87	2.37	3.75	3.78	3.78	7.50	7.50	3.75	4.25	2.37	8.00	4.25	3.75
	Line Fuse	3.0	35	45	45	25	45	45	25	4	25	40	25	25
85-Y030	Load Amps	23.4	29.6	46.8	47.3	23.6	46.8	46.8	23.4	53.1	29.6	50.0	26.5	27.0
	kVA	2.81	3.56	5.62	5.67	5.67	11.25	11.25	5.62	6.37	3.56	12.00	6.37	5.62
	Line Fuse	40	50	70	70	35	70	70	35	60	30	60	35	30
85-Y035	Load Amps	31.2	39.5	62.5	63.0	31.5	62.5	62.5	31.2	70.8	39.5	66.6	35.4	36.0
	kVA	3.75	4.75	7.50	7.57	7.57	15.00	15.00	7.50	8.50	4.75	16.00	8.50	7.50
	Line Fuse	60	70	90	90	45	90	90	50	80	40	80	45	40
85-Y040	Load Amps	46.8	59.3	93.7	94.6	47.3	93.7	93.7	46.8	106.2	59.3	100.0	53.1	54.0
	kVA	5.6	7.1	11.2	11.3	11.3	22.5	22.5	11.2	12.7	7.1	24.0	12.7	11.2
	Line Fuse	80	100	150	150	70	125	125	70	125	60	125	70	60
85-Y045	Load Amps	62.5	79.1	125.0	126.1	63.0	125.0	125.0	62.5	141.6	79.1	133.3	70.8	72.1
	kVA	7.5	9.5	15.0	15.1	15.1	30.0	30.0	15.0	17.0	9.5	32.0	17.0	15.0
	Line Fuse	110	125	200	200	90	175	175	100	175	80	150	90	80
85-Y050	Load Amps	93.7	118.7	187.5	189.2	94.6	187.5	187.5	93.7	212.5	118.7	200.0	106.2	108.1
	kVA	11.2	14.2	22.5	22.7	22.7	45.0	45.0	22.5	25.5	14.2	48.0	25.5	22.5
	Line Fuse	175	200	300	300	150	300	300	150	250	125	225	150	125
85-Y055	Load Amps	156.2	197.9	312.5	315.4	157.7	312.5	312.5	156.2	354.1	197.9	333.3	177.0	180.2
	kVA	18.7	23.7	37.5	37.8	37.8	75.0	75.0	37.5	42.5	23.7	80.0	42.5	37.5
	Line Fuse	300	350	500	450	250	450	450	250	400	200	400	250	200
Qty. Required		1	1	1	1	1	1	1	1	1	1	1	1	1
Connection Dia. Page		SP - 8 43	SP - 12 44	SP - 7 43	SP - 11 44	SP - 10 44	SP - 5 43	SP - 9 44	SP - 6 43	SP - 3 43	SP - 4 43	SP - 1 43	SP - 2 43	SP - 13 44

Single Phase Buck-Boost Sizing Tables

Single Phase Buck-Boost Table, Type LM

Type LM		Single Phase / Single Unit - Type LM													
		Boost - Increase Voltage								Buck - Decrease Voltage					
Catalog Number	Line	192	200	216	218	432	437	456	457	253	277	264	288	504	528
	Load	240	240	240	240	480	480	480	480	230	230	240	240	480	480
35-LM010	Load Amps	2.0	2.0	4.1	4.1	2.0	2.1	4.1	4.1	4.5	2.4	4.5	2.5	4.3	2.2
	kVA	0.50	0.50	1.00	1.00	1.00	1.01	2.00	1.98	1.05	0.56	1.10	0.60	2.10	1.10
	Line Fuse	5	5	8	7	5	5	7	7	7	5	7	7	5	7
35-LM015	Load Amps	3.1	3.1	6.2	6.2	3.1	3.1	6.2	6.2	6.8	3.6	6.8	3.7	6.5	3.4
	kVA	0.75	0.75	1.50	1.50	1.50	1.52	3.00	2.98	1.58	0.84	1.65	0.90	3.15	1.65
	Line Fuse	7	7	10	12	6	6	10	10	10	5	10	5	10	5
85-LM020	Load Amps	5.2	5.2	10.4	10.4	5.2	5.2	10.4	10.3	11.4	6.1	11.4	6.2	10.9	5.7
	kVA	1.25	1.25	2.50	2.50	2.50	2.54	5.00	4.96	2.63	1.41	2.75	1.50	5.25	2.75
	Line Fuse	10	10	15	15	10	10	15	15	15	9	15	9	15	9
85-LM025	Load Amps	10.4	10.4	20.8	20.8	10.4	10.5	20.8	20.6	22.9	12.2	22.9	12.5	21.8	11.4
	kVA	2.50	2.50	5.00	5.00	5.00	5.08	10.00	9.93	5.27	2.82	5.50	3.00	10.50	5.50
	Line Fuse	20	20	30	30	15	15	30	30	30	15	30	15	30	15
85-LM030	Load Amps	15.6	15.6	31.2	31.2	15.6	15.8	31.2	31.0	34.3	18.4	34.3	18.7	32.8	17.1
	kVA	3.75	3.75	7.50	7.50	7.50	7.62	15.00	14.90	7.90	4.23	8.25	4.50	15.75	8.25
	Line Fuse	25	25	45	45	25	25	45	45	40	20	20	20	40	20
85-LM035	Load Amps	20.8	20.8	41.6	41.6	20.8	21.1	41.6	41.3	45.8	24.5	45.8	25.0	43.7	22.9
	kVA	5.00	5.00	10.00	10.00	10.00	10.16	20.00	19.87	10.54	5.64	11.00	6.00	21.00	11.00
	Line Fuse	35	35	60	60	30	30	60	60	60	30	60	30	60	30
85-LM040	Load Amps	31.2	31.2	62.5	62.5	31.2	31.7	62.	62.0	68.7	36.8	68.7	37.5	65.6	34.3
	kVA	7.50	7.50	15.00	15.00	15.00	15.24	30.00	29.80	15.81	8.47	16.50	9.00	31.50	16.50
	Line Fuse	50	50	90	90	45	45	90	90	80	40	80	40	80	40
85-LM045	Load Amps	41.6	41.6	83.3	83.3	41.6	42.3	83.3	82.7	91.6	49.1	91.6	50.0	87.5	45.8
	kVA	10.0	10.0	20.0	20.0	20.0	20.3	40.0	39.7	21.0	11.2	22.0	12.0	42.0	22.0
	Line Fuse	70	70	125	125	60	60	110	110	110	60	110	60	110	60
85-LM050	Load Amps	62.5	62.5	125.0	124.9	62.5	63.5	125.0	124.1	137.5	73.6	137.5	75.0	131.2	68.7
	kVA	15.0	15.0	30.0	30.0	30.0	30.4	60.0	59.6	31.6	16.9	33.0	18.0	63.0	33.0
	Line Fuse	100	100	175	175	90	90	175	175	175	80	175	80	175	80
85-LM055	Load Amps	104.1	104.1	208.3	208.3	104.1	105.8	208.3	206.9	229.1	122.7	229.1	125.0	218.7	114.5
	kVA	25.0	25.0	50.0	50.0	50.0	50.8	100.0	99.3	52.7	28.2	55.0	30.0	105.0	55.0
	Line Fuse	175	175	300	300	150	150	300	300	300	150	300	150	300	150
Qty. Required		1	1	1	1	1	1	1	1	1	1	1	1	1	1
Connection Dia. Page		SP - 8 43	SP -12 44	SP - 7 43	SP -11 44	SP - 6 43	SP -10 44	SP - 5 43	SP - 9 44	SP - 3 43	SP - 4 43	SP - 3 43	SP - 4 43	SP - 1 43	SP - 2 43

Three Phase Buck-Boost Sizing Tables

Three Phase Buck-Boost Table, Type M

Type M		Three Phase / Two or Three Units - Type M															
		Boost - Increase Voltage										Buck - Decrease Voltage					
Catalog Number	Line	166	173	187	208	216	228	374	377	395	397	230	249	252	264	437	457
	Load	208	208	208	230	240	240	416	416	416	416	208	208	240	240	416	416
35-M005	Load Amps	1.6	2.0	3.6	4.1	1.8	3.9	1.8	2.0	3.9	4.1	4.5	2.4	4.3	2.2	4.3	2.2
	kVA	0.60	0.75	1.30	1.64	0.77	1.64	1.34	1.50	2.85	3.95	1.64	0.90	1.82	0.95	3.12	1.65
	Line Fuse	5	5	7	8	5	7	5	5	7	7	7	5	7	5	7	5
35-M010	Load Amps	3.3	4.1	7.2	8.2	3.7	7.8	3.7	4.1	7.9	8.3	9.1	4.9	8.7	4.5	8.6	4.5
	kVA	1.20	1.49	2.60	3.29	1.55	3.28	2.69	3.00	5.70	5.99	3.29	1.80	3.64	1.90	6.24	3.30
	Line Fuse	7	8	15	12	7	15	7	7.5	15	15	15	7	15	7	15	7
35-M015	Load Amps	4.9	6.2	10.8	12.4	5.5	11.8	5.6	6.2	11.8	12.4	13.7	7.4	13.1	6.8	12.9	6.8
	kVA	1.80	2.24	3.90	4.94	2.32	4.92	4.04	4.50	8.55	8.99	4.94	2.70	5.46	2.86	9.36	4.95
	Line Fuse	10	12	20	20	10	20	12	10	20	20	20	10	20	10	20	10
85-M020	Load Amps	8.3	10.4	18.0	20.6	9.3	19.7	9.3	10.4	19.7	20.8	22.8	12.4	21.9	11.4	21.6	11.4
	kVA	3.00	3.74	6.50	8.23	3.87	8.20	6.74	7.50	14.26	14.99	8.23	4.50	9.10	4.76	15.60	8.25
	Line Fuse	15	20	30	30	15	30	15	15	30	30	30	15	30	15	30	15
85-M025	Load Amps	16.6	20.8	36.0	41.3	18.6	39.4	18.7	20.8	39.5	41.6	45.7	24.9	43.8	22.9	43.3	22.9
	kVA	6.00	7.49	13.00	16.46	7.75	16.40	13.49	15.00	28.52	29.98	16.46	9.00	18.20	9.53	31.21	16.50
	Line Fuse	30	35	60	60	30	60	30	30	60	60	60	30	60	30	60	30
85-M030	Load Amps	24.9	31.2	54.1	62.0	27.9	59.1	28.0	31.2	59.3	62.42	68.5	37.4	65.7	34.4	64.9	34.3
	kVA	9.00	11.24	19.50	24.69	11.62	24.60	20.23	22.50	42.78	44.97	24.69	13.50	27.31	14.30	46.82	24.75
	Line Fuse	45	50	80	90	45	80	45	45	80	90	80	45	80	45	80	45
85-M035	Load Amps	33.3	41.6	72.1	82.6	37.2	78.9	37.4	41.6	79.1	83.2	91.4	49.9	87.6	45.8	86.6	45.8
	kVA	12.00	14.99	26.00	32.93	15.50	32.80	26.98	30.00	57.05	59.97	32.93	18.00	36.41	19.07	62.49	33.00
	Line Fuse	60	70	110	125	60	110	60	60	110	110	110	60	110	60	110	60
85-M040	Load Amps	49.9	62.4	108.2	124.0	55.9	118.3	56.17	62.45	118.7	124.8	137.1	74.9	131.4	68.8	129.9	68.7
	kVA	18.00	22.49	39.00	49.39	23.25	49.20	40.47	45.00	85.57	89.95	49.39	27.00	54.62	28.61	93.64	49.50
	Line Fuse	80	100	175	175	80	175	80	90	175	175	175	80	175	80	175	80
85-M045	Load Amps	66.6	83.2	144.3	165.3	74.5	157.8	74.8	83.2	158.3	166.4	182.8	99.9	175.2	91.7	173.2	91.6
	kVA	24.0	29.9	52.0	65.8	31.1	65.6	53.9	60.0	114.1	119.9	65.8	36.0	72.8	38.1	124.8	66.0
	Line Fuse	110	150	225	250	110	250	110	125	250	250	225	110	225	110	225	110
85-M050	Load Amps	99.9	124.8	216.5	248.0	111.8	236.7	112.3	124.9	237.5	249.6	274.2	149.9	262.8	137.6	259.9	137.4
	kVA	36.0	44.9	78.8	98.7	46.5	98.4	80.9	90.00	171.1	179.9	98.7	54.0	109.2	57.2	187.2	99.0
	Line Fuse	175	200	350	400	175	250	175	175	350	350	350	175	350	175	350	175
85-M055	Load Amps	166.6	208.1	360.8	413.3	186.4	394.5	187.2	208.1	395.9	416.1	457.0	249.8	438.0	229.4	433.2	229.0
	kVA	60.0	74.9	130.0	164.6	77.5	164.0	134.9	150.0	285.2	299.8	164.6	90.0	182.0	95.3	312.1	165.0
	Line Fuse	300	350	600	600	300	600	200	300	600	600	600	300	600	300	600	300
Qty. Required		3	3	3	3	2	2	3	3	3	3	3	3	2	2	3	3
Connection Dia. Page		TP-18 46	TP-22 47	TP-17 46	TP-21 47	TP-5 45	TP-6 45	TP-20 47	TP-24 47	TP-19 47	TP-23 47	TP-13 46	TP-14 46	TP-10 46	TP-9 45	TP-15 46	TP-16 46

Three Phase Buck-Boost Sizing Tables

Three Phase Buck-Boost Table, Type Y

Type Y		Three Phase / Two and Three Units - Type Y															
		Boost - Increase Voltage										Buck - Decrease Voltage					
Catalog Number	Line Load	152	164	180	208	208	212	224	360	388	416	263	235	240	256	272	390
		208	208	208	235	240	240	240	416	416	471	208	208	208	240	240	416
35-Y005	Load Amps	1.5	1.5	2.6	3.1	1.3	1.5	2.9	1.3	2.9	1.5	1.9	3.5	1.5	3.3	1.77	3.1
	kVA	0.55	0.55	0.96	1.27	0.56	0.64	1.21	0.96	2.09	1.25	0.69	1.27	0.56	1.38	.73	2.25
	Line Fuse	5	5	5	5	5	5	5	5	5	5	5	5	4	5	5	5.6
35-Y010	Load Amps	3.0	3.1	5.3	6.2	2.7	3.0	5.8	2.6	5.8	3.0	3.8	7.0	3.1	6.6	3.5	6.2
	kVA	1.11	1.11	1.93	2.54	1.12	1.28	2.42	1.93	4.19	2.50	1.39	2.54	1.12	2.77	1.47	4.50
	Line Fuse	5	7	10	12	5	5	10	5	12	6	5	10	5	10	5	7
35-Y015	Load Amps	4.6	4.6	8.0	9.3	4.0	4.6	8.7	4.0	8.7	4.6	5.8	10.6	4.6	10.0	5.3	9.3
	kVA	1.67	1.67	2.89	3.81	1.68	1.92	3.63	2.89	6.28	3.75	2.09	3.81	1.68	4.16	2.21	6.75
	Line Fuse	8	10	12	15	8	9	15	7.5	15	9	8	15	7	15	9	15
85-Y020	Load Amps	7.7	7.7	13.4	15.6	6.7	7.7	14.5	6.7	14.5	7.6	9.7	17.6	7.8	16.6	8.8	15.6
	kVA	2.78	2.79	4.83	6.36	2.81	3.21	6.05	4.83	10.47	6.26	3.49	6.36	2.81	6.93	3.68	11.25
	Line Fuse	12	15	25	30	15	15	25	15	25	15	15	25	10	25	15	25
85-Y025	Load Amps	15.4	15.5	26.8	31.2	13.5	15.4	29.1	13.4	29.0	15.3	19.4	35.3	15.6	33.3	17.7	31.2
	kVA	5.57	5.58	9.66	12.72	5.62	6.42	12.10	9.66	20.94	12.52	6.99	12.72	5.62	13.87	7.37	22.51
	Line Fuse	25	25	45	45	25	25	45	25	45	25	25	45	25	45	25	45
85-Y030	Load Amps	23.1	23.2	40.2	46.9	20.2	23.1	43.6	20.1	43.6	23.0	29.1	53.0	23.4	50.0	26.5	46.8
	kVA	8.35	8.38	14.49	19.09	8.43	9.64	18.15	14.49	31.42	18.78	10.49	19.09	8.43	20.80	11.05	33.76
	Line Fuse	35	45	60	70	35	35	60	35	60	35	30	60	30	60	30	70
85-Y035	Load Amps	30.9	31.0	53.6	62.5	27.0	30.9	58.2	26.8	58.1	30.7	38.8	70.6	31.2	66.7	35.4	62.4
	kVA	11.14	11.17	19.32	25.45	11.25	12.85	24.21	19.32	41.89	25.04	13.98	25.45	11.25	27.74	14.73	45.02
	Line Fuse	45	50	80	90	45	45	80	45	80	45	45	80	40	80	40	90
85-Y040	Load Amps	46.3	46.5	80.4	93.8	40.5	46.3	87.3	40.2	87.2	46.0	58.2	106.0	46.8	100.1	53.1	93.7
	kVA	16.7	16.7	28.9	38.1	16.8	19.2	36.3	28.9	62.8	37.5	20.9	38.1	16.8	41.6	22.1	67.5
	Line Fuse	60	80	125	150	60	70	125	60	125	70	60	125	60	125	70	125
85-Y045	Load Amps	61.8	62.0	107.2	125.0	54.1	61.8	116.4	53.6	116.2	61.4	77.6	141.3	62.4	133.4	70.9	124.9
	kVA	22.2	22.3	38.6	50.9	22.5	25.7	48.4	38.6	83.7	50.0	27.9	50.9	22.5	55.4	29.4	90.0
	Line Fuse	80	100	175	200	80	90	175	80	175	125	80	175	70	175	80	175
85-Y050	Load Amps	92.7	93.0	160.9	187.6	81.1	92.7	174.7	80.4	174.4	92.1	116.4	212.0	93.6	200.2	106.3	187.4
	kVA	33.4	33.5	57.9	76.3	33.7	38.5	72.6	57.9	125.6	75.1	41.9	76.3	33.7	83.2	44.2	135.0
	Line Fuse	125	175	250	300	125	150	250	150	250	150	125	250	125	250	150	250
85-Y055	Load Amps	154.6	155.1	268.1	312.7	135.3	154.6	291.2	134.0	290.7	153.5	194.1	353.3	156.1	333.7	177.2	312.4
	kVA	55.7	55.8	96.6	127.2	56.2	64.2	121.0	96.6	209.4	125.2	69.9	127.2	56.2	138.7	73.6	225.1
	Line Fuse	200	250	400	450	200	225	400	200	400	250	250	400	175	400	200	450
Qty. Required		3	3	3	3	2	2	2	3	3	3	3	3	2	2	2	3
Connection Dia. Page		TP-18 46	TP-22 47	TP-17 46	TP-21 47	TP-5 45	TP-1 45	TP-6 45	TP-20 47	TP-19 47	TP-24 47	TP-14 46	TP-13 46	TP-2 45	TP-10 46	TP-9 45	TP-23 47

Three Phase Buck-Boost Sizing Tables

Three Phase Buck-Boost Table, Type LM

Type LM		Three Phase / Two or Three Units - Type LM																	
		Boost - Increase Voltage									Buck - Decrease Voltage								
Catalog Number	Line	192	200	216	332	346	400	400	432	456	240	240	253	276	264	288	500	504	528
	Load	240	240	240	416	416	440	480	480	480	200	216	230	230	240	240	416	480	480
35-LM010	Load Amps	1.6	2.0	3.7	1.6	2.0	4.1	2.1	1.8	3.9	2.4	4.1	4.5	2.4	4.5	2.5	2.5	4.3	2.2
	kVA	0.68	0.86	1.54	1.20	1.50	3.13	1.80	1.54	3.28	0.86	1.54	1.80	0.98	1.90	1.04	1.80	3.64	1.90
	Line Fuse	5	5	7	5	5	7	5	5	7	5	6	7	5	7	5	5	7	5
35-LM015	Load Amps	2.4	3.1	5.5	2.5	3.1	6.1	3.2	2.7	5.9	3.7	6.1	6.7	3.7	6.8	3.7	3.7	6.5	3.4
	kVA	1.02	1.29	2.31	1.80	2.26	4.70	2.70	2.31	4.92	1.29	2.31	2.70	1.47	2.86	1.56	2.70	5.46	2.86
	Line Fuse	5	6	10	5	6	10	6	5	10	5	9	10	5	10	5	5	10	5
85-LM020	Load Amps	4.0	5.1	9.2	4.1	5.2	10.2	5.4	4.6	9.8	6.2	10.2	11.3	6.1	11.4	6.2	6.2	10.9	5.7
	kVA	1.70	2.15	3.85	3.00	3.76	7.83	4.50	3.85	8.20	2.15	3.85	4.51	2.46	4.76	2.60	4.50	9.10	4.76
	Line Fuse	8	10	15	9	10	15	10	8	15	8	15	15	8	15	9	9	15	9
85-LM025	Load Amps	8.1	10.3	18.5	8.3	10.4	20.5	10.8	9.2	19.7	12.4	20.8	22.6	12.3	12.9	12.5	12.5	21.9	11.4
	kVA	3.40	4.30	7.70	6.01	7.53	15.67	9.00	7.70	16.40	4.30	7.70	9.02	4.92	9.53	5.20	9.01	18.20	9.53
	Line Fuse	15	20	30	15	20	30	20	15	30	15	25	30	15	30	15	15	30	15
85-LM030	Load Amps	12.2	15.5	27.7	12.5	15.6	30.8	16.2	13.8	29.5	18.6	30.8	33.9	18.5	34.4	18.7	18.7	32.8	17.2
	kVA	5.10	6.46	11.55	9.02	11.29	23.51	13.50	11.55	24.60	6.46	11.55	13.5	7.38	14.30	7.80	13.52	27.31	14.30
	Line Fuse	25	25	45	25	25	45	25	25	45	25	45	45	25	45	25	25	45	25
85-LM035	Load Amps	16.3	20.7	37.0	16.7	20.9	41.1	21.6	18.5	39.4	24.8	41.1	45.2	24.7	45.8	25.0	25.0	43.8	22.9
	kVA	6.80	8.61	15.40	12.03	15.06	31.35	18.00	15.40	32.80	8.61	15.40	18.04	9.84	19.07	10.40	18.03	36.41	19.07
	Line Fuse	30	35	60	30	35	60	35	30	60	30	50	60	30	60	30	30	60	30
85-LM040	Load Amps	24.5	31.0	55.5	25.0	31.3	61.7	32.4	27.7	59.1	37.3	61.7	67.9	37.0	68.8	37.5	37.5	65.7	34.4
	kVA	10.2	12.9	23.1	18.0	22.5	47.0	27.0	23.1	49.2	12.9	23.1	27.0	14.7	28.6	15.6	27.0	54.6	28.6
	Line Fuse	45	50	80	45	50	90	50	45	80	45	80	80	45	80	45	45	80	45
85-LM045	Load Amps	32.7	41.4	74.0	33.4	41.8	82.2	43.3	37.0	78.9	49.7	82.3	90.5	49.4	91.7	50.0	50.0	87.6	45.8
	kVA	13.6	17.2	30.8	24.0	30.1	62.7	36.0	30.8	65.6	17.2	30.8	36.0	19.6	38.1	20.8	36.0	72.8	38.1
	Line Fuse	60	60	110	60	70	125	70	60	110	60	100	110	60	110	60	60	110	60
85-LM050	Load Amps	49.0	62.1	111.1	50.1	62.7	123.4	64.9	55.5	118.3	74.6	123.4	135.8	74.1	137.6	75.0	75.0	131.4	68.8
	kVA	20.4	25.8	46.2	36.1	45.1	94.0	54.0	46.2	98.4	25.8	46.2	54.1	29.5	57.2	31.2	54.1	109.2	57.2
	Line Fuse	80	100	175	80	100	175	100	80	175	80	150	175	80	175	80	80	175	80
85-LM055	Load Amps	81.7	103.6	185.2	83.5	104.5	205.6	108.2	92.6	197.2	124.3	205.8	226.4	123.5	229.4	125.1	125.1	219.0	114.7
	kVA	34.0	43.0	77.0	60.1	75.3	156.7	90.0	77.6	164.0	43.0	77.0	90.2	49.2	95.3	52.0	90.1	182.0	95.3
	Line Fuse	150	175	300	150	175	300	175	150	300	150	250	300	150	300	150	150	300	150
Qty. Required		2	2	2	3	3	3	3	2	2	2	2	2	2	2	2	3	2	2
Qty. Required Connection Dia. Page		TP-7 45	TP-3 45	TP-4 45	TP-18 46	TP-22 47	TP-21 47	TP-22 47	TP-5 45	TP-6 45	TP-11 46	TP-8 45	TP-12 46	TP-11 46	TP-12 46	TP-11 46	TP-14 46	TP-10 46	TP-9 45

Buck-Boost Connection Diagrams

Single Phase Connection Diagrams

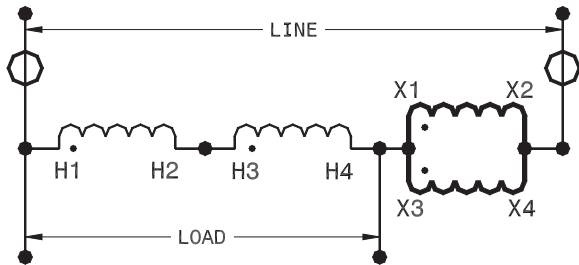

Diagram SP - 1

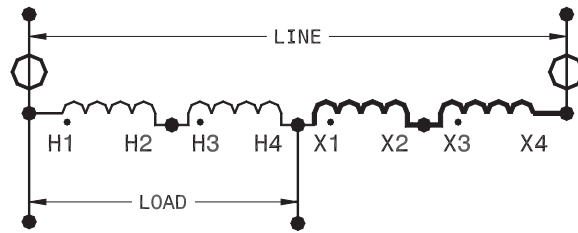

Diagram SP - 2

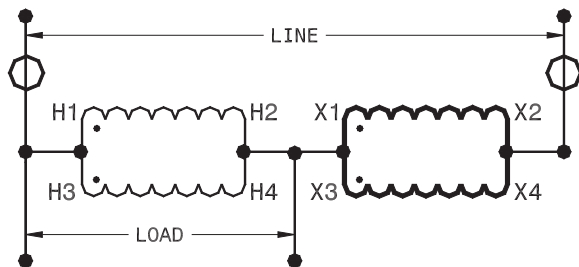

Diagram SP - 3

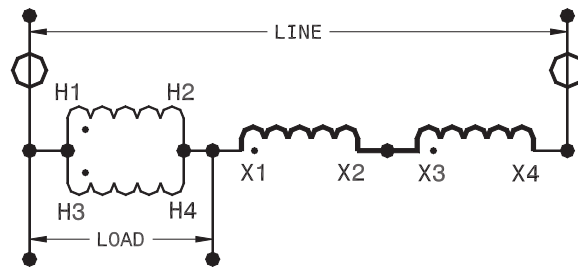

Diagram SP - 4

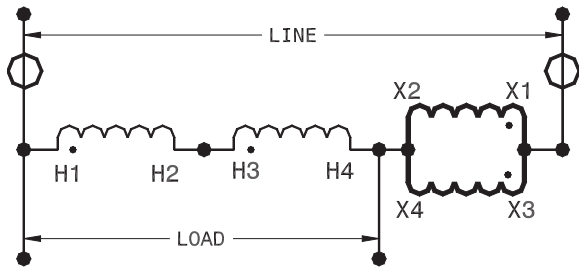

Diagram SP - 5

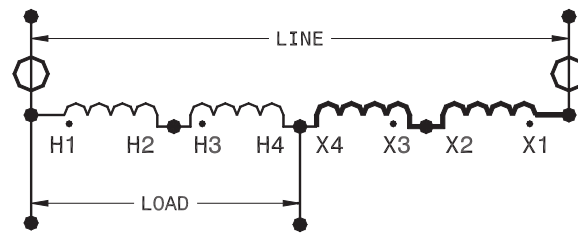

Diagram SP - 6

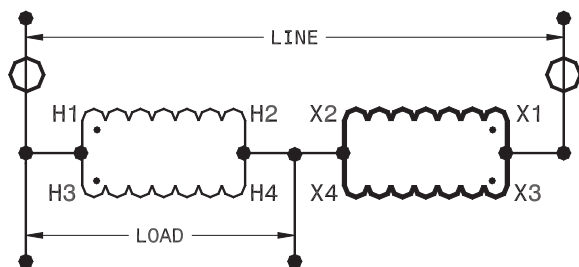

Diagram SP - 7

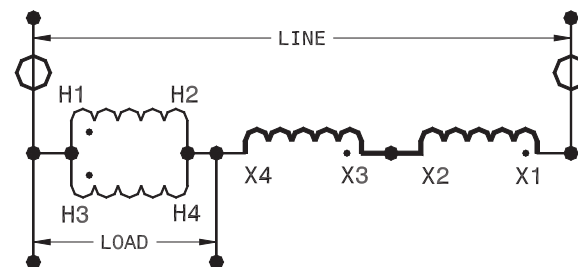

Diagram SP - 8

Buck-Boost Connection Diagrams

Single Phase Connection Diagrams

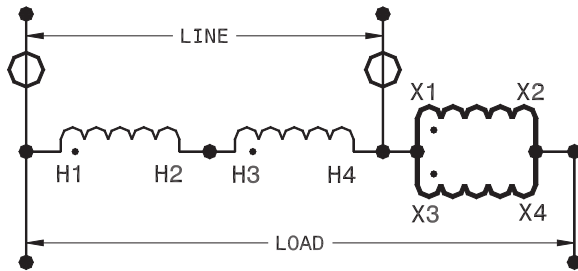

Diagram SP - 9

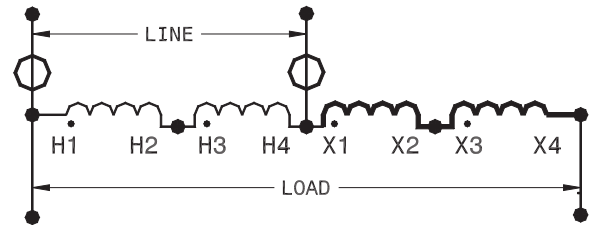

Diagram SP - 10

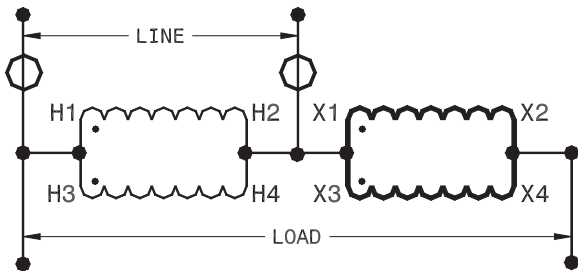

Diagram SP - 11

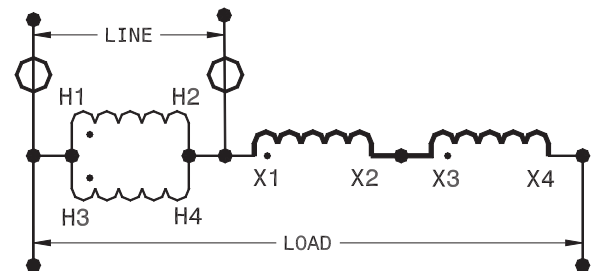

Diagram SP - 12

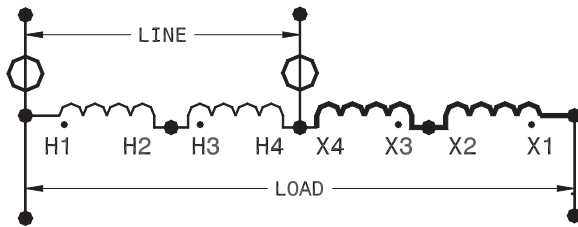

Diagram SP - 13

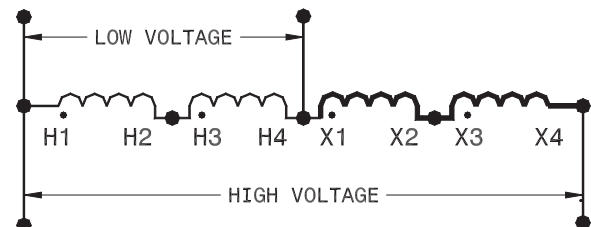

Diagram SP - 14

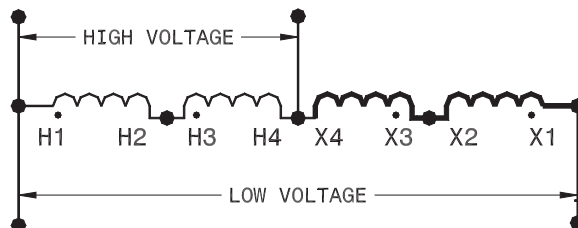

Diagram SP - 15

Symbol Key

○ - Indicates Overcurrent Protection

Note: If present, do not fuse grounded conductor

Buck-Boost Connection Diagrams

Three Phase Connection Diagrams

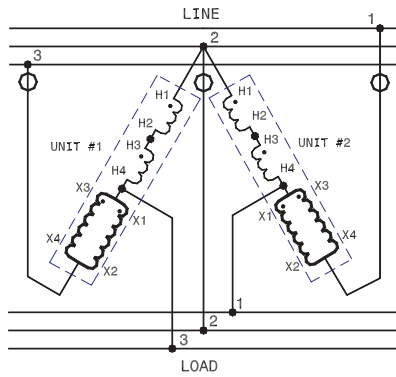

Diagram TP - 10

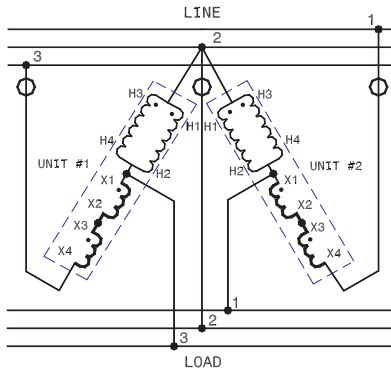

Diagram TP - 11

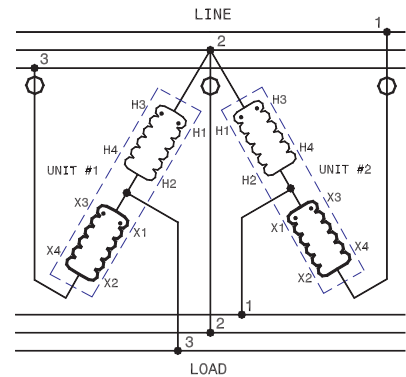

Diagram TP - 12

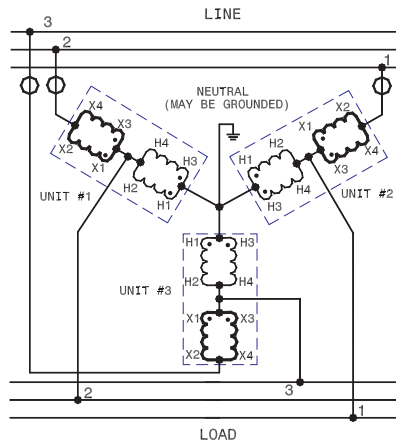

Diagram TP - 13

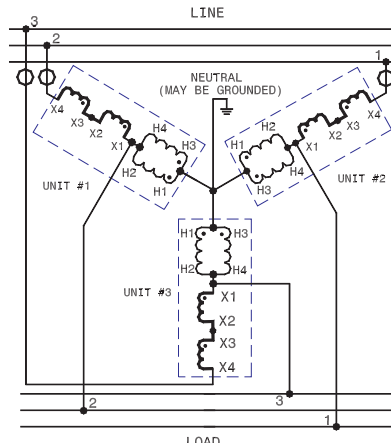

Diagram TP - 14

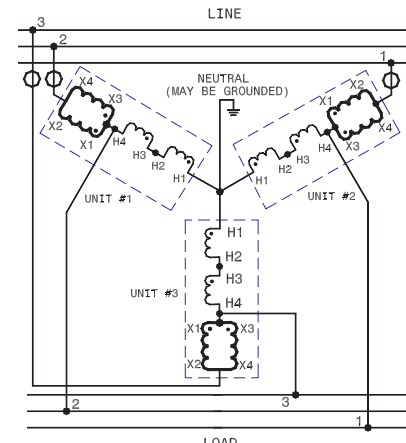

Diagram TP - 15

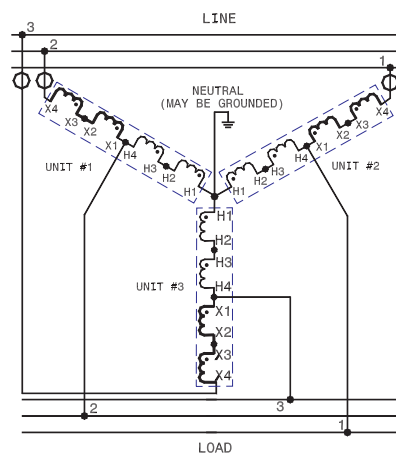

Diagram TP - 16

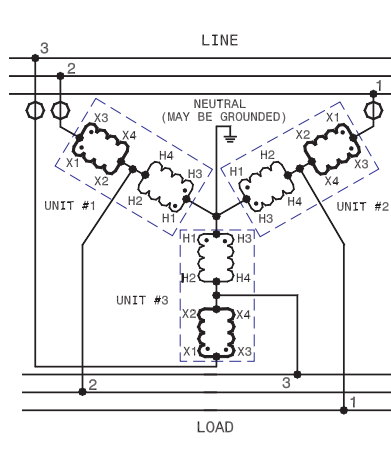

Diagram TP - 17

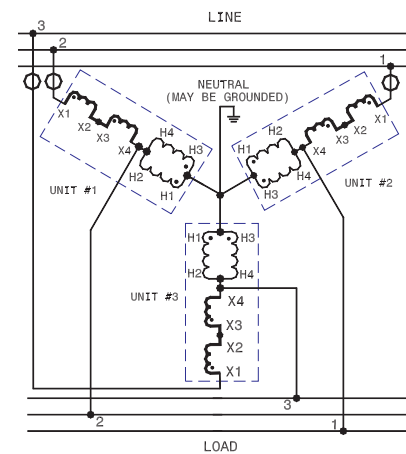

Diagram TP - 18

Buck-Boost Connection Diagrams

Three Phase Connection Diagrams

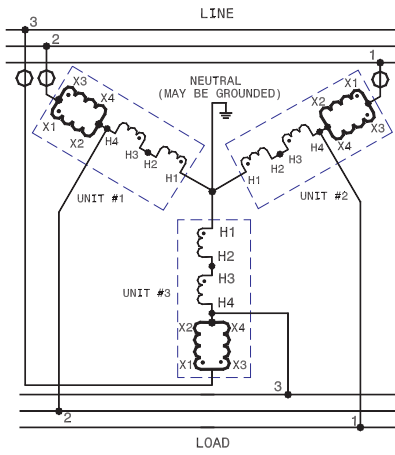

Diagram TP - 19

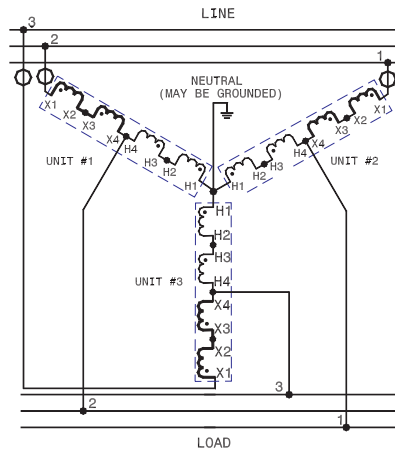

Diagram TP - 20

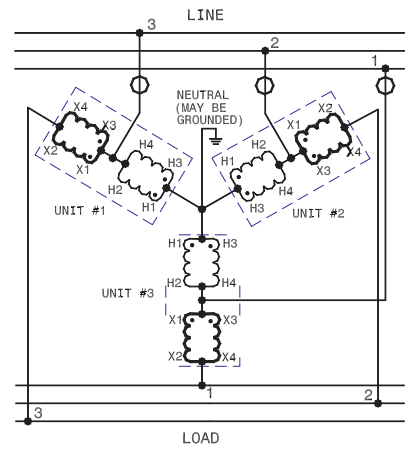

Diagram TP - 21

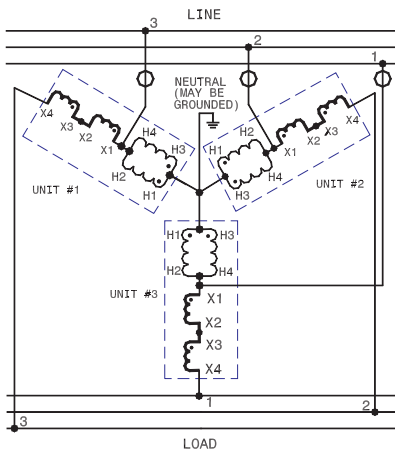

Diagram TP - 22

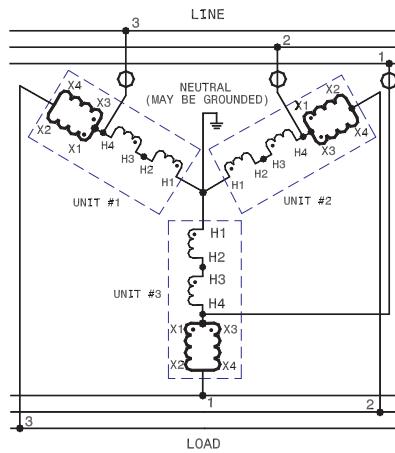

Diagram TP - 23

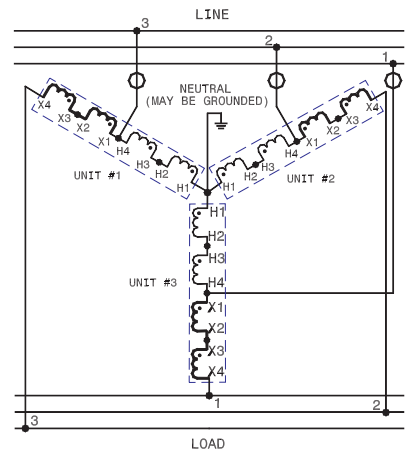

Diagram TP - 24

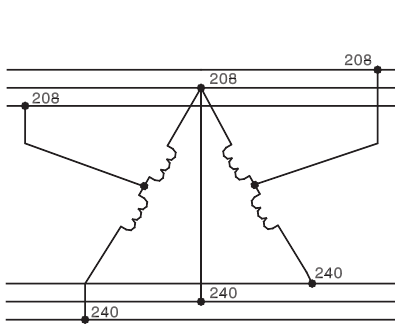

Diagram TP - 25

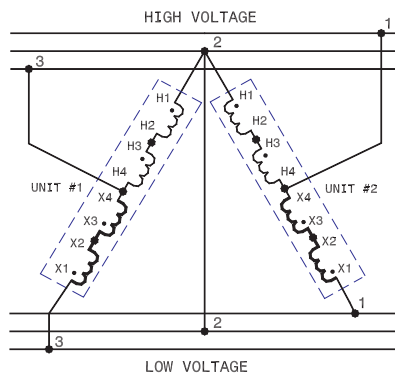

Diagram TP - 26

Symbol Key

○ - Indicates Overcurrent Protection

Note: If present, do not fuse grounded conductor

Buck-Boost Transformers

Primary Volts 120 X 240, Secondary Volts 12 / 24

General Information				Winding Specifications				Dimensions			
kVA Cap.	Catalog Number	Hz.	Wgt. Lbs	Taps	Maximum Amps		Conn Dia. Pg. 66	Height A	Width B	Depth C	Outline Dwg.
					Pri.	Sec.					
.050	35-M005*	50/60	4	0	.4 / .2	4.1 / 2.0	18	6.37	3.75	3.37	1
.100	35-M010*	50/60	5	0	.8 / .4	8.3 / 4.1	18	6.37	3.75	3.37	1
.150	35-M015*	50/60	7	0	1.2 / .6	12.5 / 6.2	18	7.00	4.00	3.63	2
.250	85-M020	50/60	15	0	2.0 / 1.0	20.8 / 10.4	18	12.00	4.87	5.25	3
.500	85-M025	50/60	19	0	4.1 / 2.0	41.6 / 20.8	18	12.00	4.87	5.25	3
.750	85-M030	50/60	23	0	6.2 / 3.1	62.5 / 31.2	18	12.00	4.87	5.25	3
1.0	85-M035	60	28	0	8 / 4	83 / 41	18	15.25	5.75	5.87	3
1.5	85-M040	60	39	0	12 / 6	125 / 62	18	15.25	5.75	5.87	3
2.0	85-M045	60	43	0	16 / 8	166 / 83	18	15.25	5.75	5.87	3
3.0	85-M050	60	69	0	25 / 12	250 / 125	18	15.25	8.25	7.87	3
5.0	85-M055	60	89	0	41 / 20	416 / 208	18	15.25	8.25	7.87	3
7.5	85-M060	60	150	0	62.5/31.3	625/312	18	19.375	13.75	11.5	3
10	85-M065	60	170	0	83.3/41.7	833/416.7	18	19.375	13.75	11.5	3

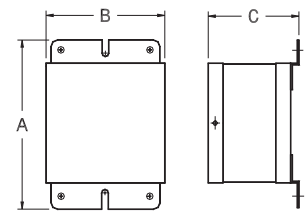

Outline Drawing 1
Wall Mount - Ventilated - NEMA Type 1

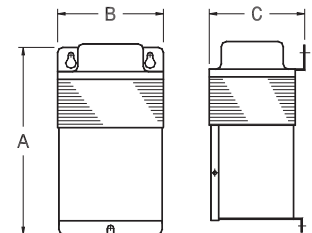

Outline Drawing 2
Wall Mount - Ventilated - NEMA Type 3R

Primary Volts 120 X 240, Secondary Volts 16 / 32

General Information				Winding Specifications				Dimensions			
kVA Cap.	Catalog Number	Hz.	Wgt. Lbs	Taps	Maximum Amps		Conn Dia. Pg. 66	Height A	Width B	Depth C	Outline Dwg.
					Pri.	Sec.					
.050	35-Y005*	50/60	4	0	.4 / .2	3.1 / 1.5	19	6.37	3.75	3.37	1
.100	35-Y010*	50/60	5	0	.8 / .4	6.2 / 3.1	19	6.37	3.75	3.37	1
.150	35-Y015*	50/60	7	0	1.2 / .6	9.3 / 4.6	19	7.00	4.00	3.63	2
.250	85-Y020	50/60	15	0	2.0 / 1.0	15.6 / 7.8	19	12.00	4.87	5.25	3
.500	85-Y025	50/60	19	0	4.1 / 2.0	31.2 / 15.6	19	12.00	4.87	5.25	3
.750	85-Y030	50/60	23	0	6.2 / 3.1	46.8 / 23.4	19	12.00	4.87	5.25	3
1.0	85-Y035	60	28	0	8 / 4	62 / 31	19	15.25	5.75	5.87	3
1.5	85-Y040	60	39	0	12 / 6	93 / 46	19	15.25	5.75	5.87	3
2.0	85-Y045	60	43	0	16 / 8	125 / 62	19	15.25	5.75	5.87	3
3.0	85-Y050	60	69	0	25 / 12	187 / 93	19	15.25	8.25	7.87	3
5.0	85-Y055	60	89	0	41 / 20	312 / 156	19	15.25	8.25	7.87	3
7.5	85-Y060	60	150	0	62.5/31.3	468.7/234.4	19	19.375	13.75	11.5	3
10	85-Y065	60	170	0	83.3/41.7	625/312.5	19	19.375	13.75	11.5	3

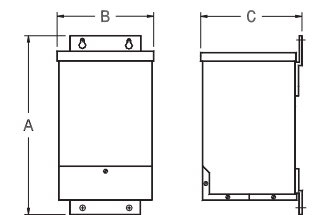

Outline Drawing 3
Wall Mount - Encapsulated - NEMA Type 3R
Note: 3 kVA & 5kVA 85 Series are also available in Outline Drawing 4 Configuration

Primary Volts 240 X 480, Secondary Volts 24 / 48

General Information				Winding Specifications				Dimensions			
kVA Cap.	Catalog Number	Hz.	Wgt. Lbs	Taps	Maximum Amps		Conn Dia. Pg. 66	Height A	Width B	Depth C	Outline Dwg.
					Pri.	Sec.					
.100	35-LM010*	50/60	5	0	.4 / .2	4.1 / 2.0	20	6.37	3.75	3.37	1
.150	35-LM015*	50/60	7	0	.6 / .3	6.2 / 3.1	20	7.00	4.00	3.63	2
.250	85-LM020	50/60	15	0	1.0 / .52	10.4 / 5.2	20	12.00	4.87	5.25	3
.500	85-LM025	50/60	19	0	2.0 / 1.0	20.8 / 10.4	20	12.00	4.87	5.25	3
.750	85-LM030	50/60	23	0	3.1 / 1.6	31.2 / 15.6	20	12.00	4.87	5.25	3
1.0	85-LM035	60	28	0	4 / 2	41 / 20	20	15.25	5.75	5.87	3
1.5	85-LM040	60	39	0	6 / 3	62 / 31	20	15.25	5.75	5.87	3
2.0	85-LM045	60	43	0	8 / 4	83 / 41	20	15.25	5.75	5.87	3
3.0	85-LM050	60	69	0	12 / 6	125 / 62	20	15.25	8.25	7.87	3
5.0	85-LM055	60	89	0	20 / 10.	208 / 104	20	15.25	8.25	7.87	3
7.5	85-Y060	60	150	0	31.3/15.6	312.5/156.3	20	19.375	13.75	11.5	3
10	85-Y065	60	170	0	41.7/20.8	416.7/208.3	20	19.375	13.75	11.5	3

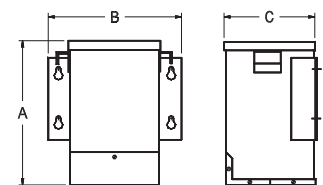

Outline Drawing 4
Wall Mount - Encapsulated - NEMA Type 3R

*Series 35 are ventilated units.

Buck-Boost Transformers

Low Voltage Connection Diagrams

Catalog Series 35-M0XX & 80-M0XX 85-M0XX			
Dia. 18	No Taps		
Tap Arrangement	High Voltage 120 X 240	Inter-Connect	Connect High Voltage Lines To
100	120	H1 To H3 H2 To H4	H1H3 & H2H4
100	240	H2 To H3	H1 & H4
Tap Arrangement	Low Voltage 12 / 24	Inter-Connect	Connect Low Voltage Lines To
100	12	X1 To X3 X2 To X4	X1X3 & X2X4
100	12 / 24	X2 To X3	X1 & X2X3 & X4
100	24	X2 To X3	X1 & X4

Catalog Series 35-Y0XX & 80-Y0XX 85-Y0XX			
Dia. 19	No Taps		
Tap Arrangement	High Voltage 120 X 240	Inter-Connect	Connect High Voltage Lines To
100	120	H1 To H3 H2 To H4	H1H3 & H2H4
100	240	H2 To H3	H1 & H4
Tap Arrangement	Low Voltage 16 / 32	Inter-Connect	Connect Low Voltage Lines To
100	16	X1 To X3 X2 To X4	X1X3 & X2X4
100	16 / 32	X2 To X3	X1 & X2X3 & X4
100	32	X2 To X3	X1 & X4

Catalog Series 35-LM0XX & 80-LM0XX 85-LM0XX			
DiDia. 20a. 20	No Taps		
Tap Arrangement	High Voltage 240 X 480	Inter-Connect	Connect High Voltage Lines To
100	240	H1 To H3 H2 To H4	H1H3 & H2H4
100	480	H2 To H3	H1 & H4
Tap Arrangement	Low Voltage 24 / 48	Inter-Connect	Connect Low Voltage Lines To
100	24	X1 To X3 X2 To X4	X1X3 & X2X4
100	24 / 48	X2 To X3	X1 & X2X3 & X4
100	48	X2 To X3	X1 & X4

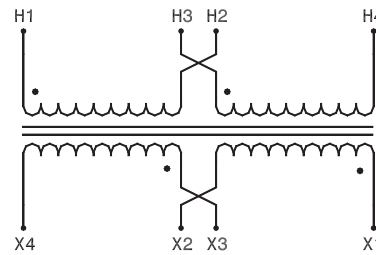
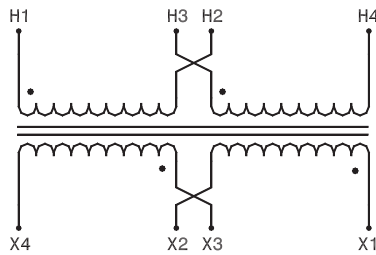
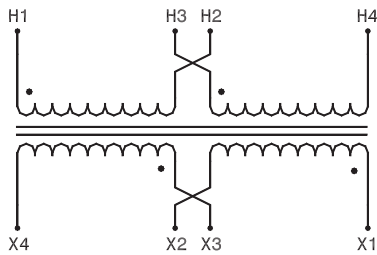

IC - Century Series Industrial Control Transformers

Features

- ◆ UL Listed, File E3210
- ◆ CUL Listed, File E3210
- ◆ CE to EN 61558
- ◆ Voltage and fuse combinations suitable for global applications
- Epoxy encapsulated copper windings
- UL Class 105°C insulation system
- Cool operation with 55°C temperature rise
- All designs rated 50 / 60 Hertz
- Combination screw heads for ease of installation
- IP 20 when finger safe terminal and/or fuse cover options are installed
- Meets or exceeds UL 5085, NEMA ST-1 and ANSI standards
- Jumper links provided

IC Series Voltage Combinations		
Suffix	Primary	Secondary
-102	120 x 240	24
-103	240 x 480	120, Triple Rated
-104	208	120
-106	600	120
-107	240 x 480	120/240, Triple Rated
-109	380/400/415	110/220
-110	208-600	85-130
-122	120 x 240	24, w/Dual Primary Fuse Holders
-123	240 x 480	120 Triple Rated, w/Dual Primary Fuse Holders
-126	600	120
-127	240 x 480	120/240, Triple Rated, w/Dual Primary Fuse Holders
-129	380/400/415	110/220, w/Dual Primary Fuse Holders

Consult the factory or your Dongan® Sales Representative for desired voltage combinations other than shown.



Primary and Secondary Fuse and Finger-Safe Options

Primary and Secondary Fuse Options

Base Unit

Base Unit with Finger-Safe Option

Suffix -102

Primary 120 x 240 - Secondary 24									Primary Max Amps	Secondary Max Amps
VA Rating	Catalog Number	Weight lbs	Dimensions (Inches/mm)			Mounting Dimensions (Inches/mm)				
			Height A	Width B	Depth C	W1	W2	D	120/240 V	24 V
50	IC-0050-102	2.7	2.63/67	3.00/76	3.94/100	2.10/53.3	2.50/63.5	2.00/51	.42/.21	2.08
75	IC-0075-102	3.7	2.63/67	3.00/76	4.44/113	2.10/53.3	2.50/63.5	2.50/64	.63/.31	3.13
100	IC-0100-102	4.2	2.94/75	3.38/86	4.19/106	2.44/62	2.813/71.5	2.38/60	.83/.42	4.17
150	IC-0150-102	6.8	3.25/83	3.75/95	4.63/117	2.75/70	3.13/79	2.75/70	1.25/.63	6.25
250	IC-0250-102	9.2	3.88/98	4.50/114	4.44/113	3.56/90	3.94/100	2.75/70	2.08/1.04	10.42
350	IC-0350-102	12.5	3.88/98	4.50/114	5.44/138	3.56/90	3.94/100	3.75/95	2.92/1.46	14.58
500	IC-0500-102	18.2	4.50/114	5.25/133	5.44/138	4.00/101	4.38/111	3.63/92	4.17/2.08	20.83
750	IC-0750-102	22.2	5.00/127	5.25/133	6.94/176	4.00/101	4.38/111	5.25/133	6.25/3.13	31.25
1000	IC-1000-102	28.4	5.00/127	5.25/133	6.94/176	4.00/101	4.38/111	5.25/133	8.33/4.17	41.67

Suffix -103

Primary 240 x 480, 230 x 460, 220 x 440 - Secondary 120, 115, 110, Triple Rated									Primary Max Amps	Secondary Max Amps
VA Rating	Catalog Number	Weight lbs	Dimensions (Inches/mm)			Mounting Dimensions (Inches/mm)				
			Height A	Width B	Depth C	W1	W2	D	240/480 V	120 V
50	IC-0050-103	2.7	2.63/67	3.00/76	3.94/100	2.10/53.3	2.50/63.5	2.00/51	.21/.10	.41
75	IC-0075-103	3.7	2.63/67	3.00/76	4.44/113	2.10/53.3	2.50/63.5	2.50/64	.31/.16	.62
100	IC-0100-103	4.2	2.94/75	3.38/86	4.19/106	2.44/62	2.813/71.5	2.38/60	.42/.21	.83
150	IC-0150-103	6.8	3.25/83	3.75/95	4.63/117	2.75/70	3.13/79	2.75/70	.63/.31	1.25
250	IC-0250-103	9.2	3.88/98	4.50/114	4.44/113	3.56/90	3.94/100	2.75/70	1.04/.52	2.08
350	IC-0350-103	12.5	3.88/98	4.50/114	5.44/138	3.56/90	3.94/100	3.75/95	1.46/.73	2.91
500	IC-0500-103	18.2	4.50/114	5.25/133	5.44/138	4.00/101	4.38/111	3.63/92	2.08/1.04	4.16
750	IC-0750-103	22.2	5.00/127	5.25/133	6.94/176	4.00/101	4.38/111	5.25/133	3.13/1.56	6.25
1000	IC-1000-103	28.4	5.00/127	5.25/133	6.94/176	4.00/101	4.38/111	5.25/133	4.17/2.08	8.33
1500	IC-1500-103	32	6.75/171	7.50/190	6.25/159	4.25/108	5.31/135	4.50/114	6.25/3.125	12.5
2000	IC-2000-103	38	6.75/172	7.50/191	7.25/184	4.25/109	5.31/135	5.50/140	8.3/4.16	16.7
3000	IC-3000-103	50	6.75/173	7.50/192	8.25/210	4.25/110	5.31/135	6.50/165	12.5/6.25	25

Suffix -104

Primary 208 - Secondary 120									Primary Max Amps	Secondary Max Amps
VA Rating	Catalog Number	Weight lbs	Dimensions (Inches/mm)			Mounting Dimensions (Inches/mm)				
			Height A	Width B	Depth C	W1	W2	D	120/240 V	24 V
50	IC-0050-104	2.7	2.63	3.00	3.94	2.10	2.50	2.00	0.24	0.42
75	IC-0075-104	3.7	2.63	3.00	4.44	2.10	2.50	2.50	0.36	0.625
100	IC-0100-104	4.2	2.94	3.38	4.19	2.44	2.80	2.38	0.48	0.83
150	IC-0150-104	6.8	3.25	3.75	4.63	2.75	3.00	2.75	0.72	1.25
250	IC-0250-104	9.2	3.88	4.50	4.44	3.56	3.94	2.75	1.2	2.08
350	IC-0350-104	12.5	3.88	4.50	5.44	3.56	3.94	3.75	1.69	2.9
500	IC-0500-104	18.2	4.5	5.25	5.44	4.00	4.38	3.63	2.4	4.1

Suffix -106

Primary 600 - Secondary 120									Primary Max Amps	Secondary Max Amps
VA Rating	Catalog Number	Weight lbs	Dimensions (Inches/mm)			Mounting Dimensions (Inches/mm)				
			Height A	Width B	Depth C	W1	W2	D	120/240 V	120 V
50	IC-0050-106	2.7	2.63	3.00	3.94	2.10	2.50	2.00	0.08	0.42
75	IC-0075-106	3.7	2.63	3.00	4.44	2.10	2.50	2.50	0.12	0.625
100	IC-0100-106	4.2	2.94	3.38	4.19	2.44	2.80	2.38	0.17	0.83
150	IC-0150-106	6.8	3.25	3.75	4.63	2.75	3.00	2.75	0.25	1.25
250	IC-0250-106	9.2	3.88	4.50	4.44	3.56	3.94	2.75	0.41	2.08
350	IC-0350-106	12.5	3.88	4.50	5.44	3.56	3.94	3.75	0.58	2.9
500	IC-0500-106	18.2	4.5	5.25	5.44	4.00	4.38	3.63	0.83	4.1

Suffix -107

Primary 240 x 480, 230 x 460, 220 x 440 - Secondary 120/240, 115/230, 110/220 Triple Rated									Primary Max Amps	Secondary Max Amps
VA Rating	Catalog Number	Weight lbs	Dimensions (Inches/mm)			Mounting Dimensions (Inches/mm)				
			Height A	Width B	Depth C	W1	W2	D	240/480 V	120/240 V
50	IC-0050-107	2.7	2.63/67	3.00/76	3.94/100	2.10/53.3	2.50/63.5	2.00/51	.21/.10	.41/.21
75	IC-0075-107	3.7	2.63/67	3.00/76	4.44/113	2.10/53.3	2.50/63.5	2.50/64	.31/.16	.63/.31
100	IC-0100-107	4.2	2.94/75	3.38/86	4.19/106	2.44/62	2.813/71.5	2.38/60	.42/.21	.83/.42
150	IC-0150-107	6.8	3.25/83	3.75/95	4.63/117	2.75/70	3.13/79	2.75/70	.63/.31	1.25/.63
250	IC-0250-107	9.2	3.88/98	4.50/114	4.44/113	3.56/90	3.94/100	2.75/70	1.04/.52	2.08/1.04
350	IC-0350-107	12.5	3.88/98	4.50/114	5.44/138	3.56/90	3.94/100	3.75/95	1.46/.73	2.92/1.46
500	IC-0500-107	18.2	4.50/114	5.25/133	5.44/138	4.00/101	4.38/111	3.63/92	2.08/1.04	4.17/2.08
750	IC-0750-107	22.2	5.00/127	5.25/133	6.94/176	4.00/101	4.38/111	5.25/133	3.13/1.56	6.25/3.13
1000	IC-1000-107	28.4	5.00/127	5.25/133	6.94/176	4.00/101	4.38/111	5.25/133	4.17/2.08	8.33/4.17
1500	IC-1500-107	32	6.75/171	7.50/190	6.25/159	4.25/108	5.31/135	4.50/114	6.25/3.125	12.5/6.25
2000	IC-2000-107	38	6.75/172	7.50/191	7.25/184	4.25/109	5.31/135	5.50/140	8.3/4.16	16.7/8.3
3000	IC-3000-107	50	6.75/173	7.50/192	8.25/210	4.25/110	5.31/135	6.50/165	12.5/6.25	25/12.5

Dimensions and weights may change. Consult factory for Certified Drawings.

Suffix -109

Primary 380/400/415 - Secondary 110/220									Primary Max Amps	Secondary Max Amps
VA Rating	Catalog Number	Weight lbs	Dimensions (Inches/mm)			Mounting Dimensions (Inches/mm)				
			Height A	Width B	Depth C	W1	W2	D	380/400/415 V	110/220 V
50	IC-0050-109	2.7	2.63/67	3.00/76	3.94/100	2.10/53.3	2.50/63.5	2.00/51	.13/.13/.12	.45/.23
75	IC-0075-109	3.7	2.63/67	3.00/76	4.44/113	2.10/53.3	2.50/63.5	2.50/64	.20/.19/.18	.68/.34
100	IC-0100-109	4.2	2.94/75	3.38/86	4.19/106	2.44/62	2.813/71.5	2.38/60	.26/.25/.24	.91/.45
150	IC-0150-109	6.8	3.25/83	3.75/95	4.63/117	2.75/70	3.13/79	2.75/70	.39/.38/.36	1.36/.68
250	IC-0250-109	9.2	3.88/98	4.50/114	4.44/113	3.56/90	3.94/100	2.75/70	.66/.63/.60	2.27/1.14
350	IC-0350-109	12.5	3.88/98	4.50/114	5.44/138	3.56/90	3.94/100	3.75/95	.92/.88/.84	3.18/1.59
500	IC-0500-109	18.2	4.50/114	5.25/133	5.44/138	4.00/101	4.38/111	3.63/92	1.32/1.25/1.20	4.55/2.27
750	IC-0750-109	22.2	5.00/127	5.25/133	6.94/176	4.00/101	4.38/111	5.25/133	1.97/1.88/1.81	6.82/3.41
1000	IC-1000-109	28.4	5.00/127	5.25/133	6.94/176	4.00/101	4.38/111	5.25/133	2.63/2.50/2.41	9.09/4.55
1500	IC-3000-109	32	6.75/171	7.50/190	6.25/159	4.25/108	5.31/135	4.50/114	3.95/3.75/3.61	13.6/6.81
2000	IC-3000-109	38	6.75/172	7.50/191	7.25/184	4.25/109	5.31/135	5.50/140	5.26/5/4.81	18.1/9.09
3000	IC-3000-109	50	6.75/173	7.50/192	8.25/210	4.25/110	5.31/135	6.50/165	7.89/7.50/7.22	27.3/13.6

Suffix -110

Primary 208/220/230/240/380/400/415/440/460/480/500/550/575/600 Secondary 85/100/110, 91/110/120, 95/115/125, 99/120/130									Primary Max Amps	Secondary Max Amps
VA Rating	Catalog Number	Weight lbs	Dimensions (Inches/mm)			Mounting Dimensions (Inches/mm)				
			Height A	Width B	Depth C	W1	W2	D	120/240 V	120 V
50	IC-0050-110	2.7	2.63	3.00	3.94	2.10	2.50	2.00		0.42
75	IC-0075-110	3.7	2.63	3.00	4.44	2.10	2.50	2.50		0.625
100	IC-0100-110	4.2	2.94	3.38	4.19	2.44	2.80	2.38		0.83
150	IC-0150-110	6.8	3.25	3.75	4.63	2.75	3.00	2.75		1.25
250	IC-0250-110	9.2	3.88	4.50	4.44	3.56	3.94	2.75		2.08
350	IC-0350-110	12.5	3.88	4.50	5.44	3.56	3.94	3.75		2.9
500	IC-0500-110	18.2	4.5	5.25	5.44	4.00	4.38	3.63		4.1

Suffix -122

Primary 120 x 240 - Secondary 24 Featuring Factory Installed Dual Primary Fuse Holders									Primary Max Amps	Secondary Max Amps
VA Rating	Catalog Number	Weight lbs	Dimensions (Inches/mm)			Mounting Dimensions (Inches/mm)				
			Height A	Width B	Depth C	W1	W2	D	120/240 V	24 V
50	IC-0050-122	2.7	4.88/124	3.00/76	3.94/100	2.10/53.3	2.50/63.5	2.00/51	.42/.21	2.08
75	IC-0075-122	3.7	4.88/124	3.00/76	4.44/113	2.10/53.3	2.50/63.5	2.50/64	.63/.31	3.13
100	IC-0100-122	4.2	5.19/132	3.38/86	4.19/106	2.44/62	2.813/71.5	2.38/60	.83/.42	4.17
150	IC-0150-122	6.8	5.50/140	3.75/95	4.63/117	2.75/70	3.13/79	2.75/70	1.25/.63	6.25
250	IC-0250-122	9.2	6.13/156	4.50/114	4.44/113	3.56/90	3.94/100	2.75/70	2.08/1.04	10.42
350	IC-0350-122	12.5	6.13/156	4.50/114	5.44/138	3.56/90	3.94/100	3.75/95	2.92/1.46	14.58
500	IC-0500-122	18.2	6.75/171	5.25/133	5.44/138	4.00/101	4.38/111	3.63/92	4.17/2.08	20.83
750	IC-0750-122	22.2	6.75/171	5.25/133	6.94/176	4.00/101	4.38/111	5.25/133	6.25/3.13	31.25
1000	IC-1000-122	28.4	6.75/171	5.25/133	6.94/176	4.00/101	4.38/111	5.25/133	8.33/4.17	41.67

*Factory installed three pole fuse holders are available by ordering suffix -132. Note: The two primary fuse positions are rejection style (Class CC). Fuses are sold separately.

Suffix -124

PRIMARY:208 SECONDARY 120									Primary Max Amps	Secondary Max Amps
VA Rating	Catalog Number	Weight lbs	Dimensions (Inches/mm)			Mounting Dimensions (Inches/mm)				
			Height A	Width B	Depth C	W1	W2	D	120/240 V	120 V
50	IC-0050-124	2.7	4.88/124	3	3.94	2.1	2.5	2	0.24	0.42
75	IC-0075-124	3.7	4.88/125	3	4.44	2.1	2.5	2.5	0.36	0.625
100	IC-0100-124	4.2	5.19/132	3.38	4.19	2.44	2.8	2.38	0.48	0.83
150	IC-0150-124	6.8	5.50/140	3.75	4.63	2.75	3	2.75	0.72	1.25
250	IC-0250-124	9.2	6.13/156	4.5	4.44	3.56	3.94	2.75	1.2	2.08
350	IC-0350-124	12.5	6.13/157	4.5	5.44	3.56	3.94	3.75	1.69	2.9
500	IC-0500-124	18.2	6.75/171	5.25	5.44	4	4.38	3.63	2.4	4.1

Suffix -123

Primary 240 x 480, 230 x 460, 220 x 440 - Secondary 120, 115, 110, Triple Rated Featuring Factory Installed Dual Primary Fuse Holders									Primary Max Amps	Secondary Max Amps
VA Rating	Catalog Number	Weight lbs	Dimensions (Inches/mm)			Mounting Dimensions (Inches/mm)				
			Height A	Width B	Depth C	W1	W2	D	240/480 V	120 V
50	IC-0050-123	2.7	4.88/124	3.00/76	3.94/100	2.10/53.3	2.50/63.5	2.00/51	.21/.10	.41
75	IC-0075-123	3.7	4.88/124	3.00/76	4.44/113	2.10/53.3	2.50/63.5	2.50/64	.31/.16	.62
100	IC-0100-123	4.2	5.19/132	3.38/86	4.19/106	2.44/62	2.813/71.5	2.38/60	.42/.21	.83
150	IC-0150-123	6.8	5.50/140	3.75/95	4.63/117	2.75/70	3.13/79	2.75/70	.63/.31	1.25
250	IC-0250-123	9.2	6.13/156	4.50/114	4.44/113	3.56/90	3.94/100	2.75/70	1.04/.52	2.08
350	IC-0350-123	12.5	6.13/156	4.50/114	5.44/138	3.56/90	3.94/100	3.75/95	1.46/.73	2.91
500	IC-0500-123	18.2	6.75/171	5.25/133	5.44/138	4.00/101	4.38/111	3.63/92	2.08/1.04	4.16
750	IC-0750-123	22.2	6.75/171	5.25/133	6.94/176	4.00/101	4.38/111	5.25/133	3.13/1.56	6.25
1000	IC-1000-123	28.4	6.75/171	5.25/133	6.94/176	4.00/101	4.38/111	5.25/133	4.17/2.08	8.33
1500	IC-1500-123	32	8.25/209.6	7.50/190	6.25/159	4.25/108	5.31/135	4.50/114	6.25/3.12	12.5
2000	IC-2000-123	38	8.25/209.6	7.50/191	7.25/184	4.25/109	5.31/136	5.50/140	8.33/4.16	16.66
3000	IC-3000-123	50	8.25/209.6	7.50/192	8.25/210	4.25/110	5.31/137	6.50/165	12.5/6.25	25

*Factory installed three pole fuse holders are available by ordering suffix -132. Note: The two primary fuse positions are rejection style (Class CC). Fuses are sold separately.

Dimensions and weights may change. Consult factory for Certified Drawings.

Suffix -126

PRIMARY: 600 SECONDARY: 120									Primary Max Amps	Secondary Max Amps
VA Rating	Catalog Number	Weight lbs	Dimensions (Inches/mm)			Mounting Dimensions (Inches/mm)				
			Height A	Width B	Depth C	W1	W2	D	120/240 V	120 V
50	IC-0050-126	2.7	4.88/124	3	3.94	2.1	2.5	2	0.08	0.42
75	IC-0075-126	3.7	4.88/125	3	4.44	2.1	2.5	2.5	0.12	0.625
100	IC-0100-126	4.2	5.19/132	3.38	4.19	2.44	2.8	2.38	0.17	0.83
150	IC-0150-126	6.8	5.50/140	3.75	4.63	2.75	3	2.75	0.25	1.25
250	IC-0250-126	9.2	6.13/156	4.5	4.44	3.56	3.94	2.75	0.41	2.08
350	IC-0350-126	12.5	6.13/157	4.5	5.44	3.56	3.94	3.75	0.58	2.9
500	IC-0500-126	18.2	6.75/171	5.25	5.44	4	4.38	3.63	0.83	4.1

Suffix -127

Primary 240 x 480, 230 x 460, 220 x 440 - Secondary 120/240, 115/230, 110/220 Triple Rated Featuring Factory Installed Dual Primary Fuse Holders									Primary Max Amps	Secondary Max Amps
VA Rating	Catalog Number	Weight lbs	Dimensions (Inches/mm)			Mounting Dimensions (Inches/mm)			240/480 V	120/240 V
			Height A	Width B	Depth C	W1	W2	D		
50	IC-0050-127	2.7	4.88/124	3.00/76	3.94/100	2.10/53.3	2.50/63.5	2.00/51	.21/.10	.41/.21
75	IC-0075-127	3.7	4.88/124	3.00/76	4.44/113	2.10/53.3	2.50/63.5	2.50/64	.31/.16	.63/.31
100	IC-0100-127	4.2	5.19/132	3.38/86	4.19/106	2.44/62	2.813/71.5	2.38/60	.42/.21	.83/.42
150	IC-0150-127	6.8	5.50/140	3.75/95	4.63/117	2.75/70	3.13/79	2.75/70	.63/.31	1.25/.63
250	IC-0250-127	9.2	6.13/156	4.50/114	4.44/113	3.56/90	3.94/100	2.75/70	1.04/.52	2.08/1.04
350	IC-0350-127	12.5	6.13/156	4.50/114	5.44/138	3.56/90	3.94/100	3.75/95	1.46/.73	2.92/1.46
500	IC-0500-127	18.2	6.75/171	5.25/133	5.44/138	4.00/101	4.38/111	3.63/92	2.08/1.04	4.17/2.08
750	IC-0750-127	22.2	6.75/171	5.25/133	6.94/176	4.00/101	4.38/111	5.25/133	3.13/1.56	6.25/3.13
1000	IC-1000-127	28.4	6.75/171	5.25/133	6.94/176	4.00/101	4.38/111	5.25/133	4.17/2.08	8.33/4.17
1500	IC-1500-127	32	8.25/209.6	7.50/190	6.25/159	4.25/108	5.31/135	4.50/114	6.25/3.12	12.5/6.25
2000	IC-2000-127	38	8.25/209.7	7.50/191	7.25/184	4.25/109	5.31/136	5.50/140	8.33/4.16	16.66/8.33
3000	IC-3000-127	50	8.25/209.8	7.50/192	8.25/210	4.25/110	5.31/137	6.50/165	12.5/6.25	25/12.5

*Factory installed three pole fuse holders are available by ordering suffix -132. Note: The two primary fuse positions are rejection style (Class CC). Fuses are sold separately.

Suffix -129

Primary 380/400/415 - Secondary 110/220 Featuring Factory Installed Dual Primary Fuse Holders									Primary Max Amps	Secondary Max Amps
VA Rating	Catalog Number	Weight lbs	Dimensions (Inches/mm)			Mounting Dimensions (Inches/mm)			380/400/415 V	110/220 V
			Height A	Width B	Depth C	W1	W2	D		
50	IC-0050-129	2.7	4.88/124	3.00/76	3.94/100	2.10/53.3	2.50/63.5	2.00/51	.13/.13/.12	.45/.23
75	IC-0075-129	3.7	4.88/124	3.00/76	4.44/113	2.10/53.3	2.50/63.5	2.50/64	.20/.19/.18	.68/.34
100	IC-0100-129	4.2	5.19/132	3.38/86	4.19/106	2.44/62	2.813/71.5	2.38/60	.26/.25/.24	.91/.45
150	IC-0150-129	6.8	5.50/140	3.75/95	4.63/117	2.75/70	3.13/79	2.75/70	.39/.38/.36	1.36/.68
250	IC-0250-129	9.2	6.13/156	4.50/114	4.44/113	3.56/90	3.94/100	2.75/70	.66/.63/.60	2.27/1.14
350	IC-0350-129	12.5	6.13/156	4.50/114	5.44/138	3.56/90	3.94/100	3.75/95	.92/.88/.84	3.18/1.59
500	IC-0500-129	18.2	6.75/171	5.25/133	5.44/138	4.00/101	4.38/111	3.63/92	1.32/1.25/1.20	4.55/2.27
750	IC-0750-129	22.2	6.75/171	5.25/133	6.94/176	4.00/101	4.38/111	5.25/133	1.97/1.88/1.81	6.82/3.41
1000	IC-1000-129	28.4	6.75/171	5.25/133	6.94/176	4.00/101	4.38/111	5.25/133	2.63/2.50/2.41	9.09/4.55

*Factory installed three pole fuse holders are available by ordering suffix -132. Note: The two primary fuse positions are rejection style (Class CC). Fuses are sold separately.

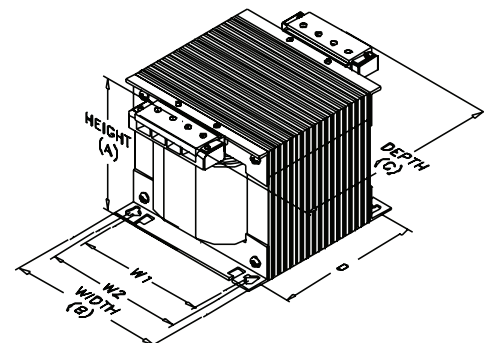

Dimensions and weights may change. Consult factory for Certified Drawings.

IC Century Series

Suffix -102 & -122				
Primary			Secondary	
Voltage	Jumper	Connect Incoming Lines To	Voltage	Connect Load To
120	H1 to H3 & H2 to H4	H1 & H4	24	X1 & X2
240	H2 to H3	H1 & H4		

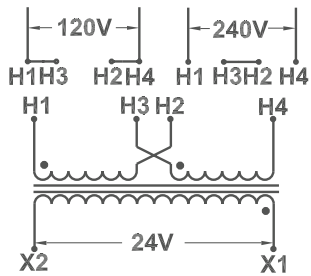

Suffix -103 & -123				
Primary			Secondary	
Voltage	Jumper	Connect Incoming Lines To	Voltage	Connect Load To
240	H1 to H3 & H2 to H4	H1 & H4	120	X1 & X2
230			115	
220			110	
480	H2 to H3	H1 & H4		
460				
440				

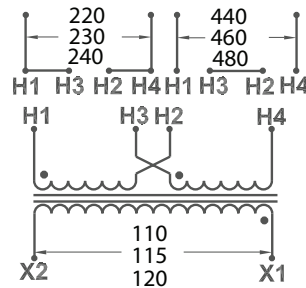

Suffix -104				
Primary			Secondary	
Voltage	Jumper	Connect Incoming Lines To	Voltage	Connect Load To
208	-	H1 & H2	120	X1 & X2

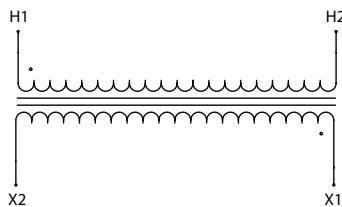

Suffix -106				
Primary			Secondary	
Voltage	Jumper	Connect Incoming Lines To	Voltage	Connect Load To
600	-	H1 & H2	120	X1 & X2
575			115	X1 & X2
550			110	X1 & X2

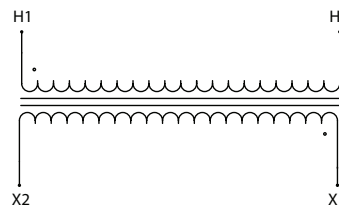

Suffix -107 & -127

Primary			Secondary		
Voltage	Jumper	Connect Incoming Lines To	Voltage	Jumper	Connect Load To
240	H1 to H3	H1 & H4	120	X1 to X3	X1 & X4
230	&		115	&	
220	H2 to H4		110	X2 to X4	
480	H2 to H3	H1 & H4	120	X1 to X3	X1 & X4
460			115	&	
440			110	X2 to X4	
240	H1 to H3	H1 & H4	240	X2 to X3	X1 & X4
230	&		230		
220	H2 to H4		220		
480	H2 to H3	H1 & H4	240	X2 to X3	X1 & X4
460			230		
440			220		

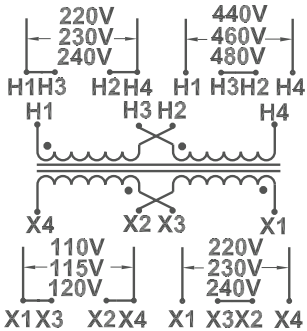

Suffix -109 & -129

Primary			Secondary		
Voltage	Jumper	Connect Incoming Lines To	Voltage	Jumper	Connect Load To
380	-	H1 & H2	110	X1 to X3	X1 & X4
400	-	H1 & H3		X2 to X4	
415	-	H1 & H4	220	X2 to X3	X1 & X4

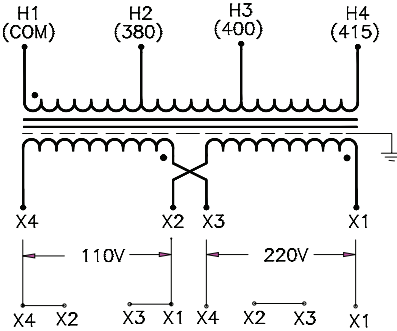

Suffix -110

Primary				Secondary		
Connect Incoming Lines To H1 & H2	Connect Incoming Lines To H1 & H3	Connect Incoming Lines To H1 & H4	Connect Incoming Lines To H1 & H5	Connect Load To X1 & X2	Connect Load To X1 & X3	Connect Load To X1 & X4
208	-	-	500	85	100	110
220	380	440	550	91	110	120
230	400	460	575	95	115	125
240	416	480	600	99	120	130

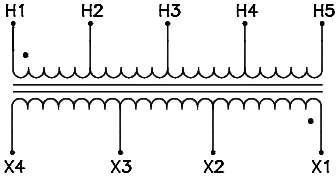

Series IC - Accessory Installation Instructions

Series IC Secondary Fuse Kit FCSEC 13/32" x 1 1/4" Fuses			
	Max. Torque In-Lbs.	Wire Size Rating	Max. Fuse Rating

Terminal Screw	18	10 - 22 AWG	30 Amps @ 250 Volts
----------------	----	-------------	---------------------

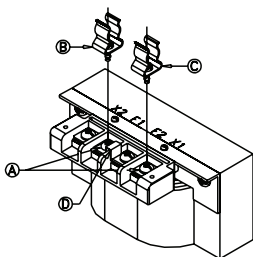

Fusing X1 Side of Secondary

- Remove the screws from F1 & X1
- Install Jumper Link (D) along with the 2 Fuse Clips (B & C) using a 10-32 Screw provided.
- Connect one side of Jumper Link to F1 and the other to F2. Insure the fuse clip end stops are facing away from each other.
- Tighten screws to rated torque from chart above. Do not overtighten.
- Connect the secondary load wires to F2 and X2.

Fusing X2 Side of Secondary

- Remove the screws from F2 & X2
- Install Jumper Link (D) along with the 2 Fuse Clips (B & C) using a 10-32 Screw provided.
- Connect one side of Jumper Link to F2 and the other to F1. Insure the fuse clip end stops are facing away from each other.
- Tighten screws to rated torque from chart above. Do not overtighten.
- Connect the secondary load wires to F1 and X1.

FCSEC Fuse Kit Contents

- 2 Fuse Clips
- 2 #10-32 Screws
- 1 Jumper Link
- 1 Instruction Sheet

Series IC Primary Fuse Kit FP2 Type CC Fuses			
	Max. Torque In-Lbs.	Wire Size Rating	Max. Fuse Rating

Terminal Block	18	10 - 22 AWG	30 Amps @ 600 Volts
----------------	----	-------------	---------------------

Fuse Block	20	10 - 22 AWG	
------------	----	-------------	--

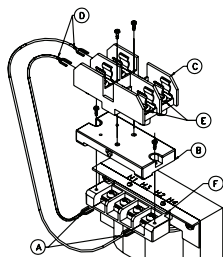

- Verify the primary jumpers are in the correct location for the desired input voltage.
- Connect one end of one of the Jumpers (A) to H1 and the other side to H4. (If using only fuse, connect one primary source wire to H4)
- Mount the Fuse Adapter Plate (B) to the Terminal Block using the 2 thread forming screws. The ridge on the bottom of the Fuse Adapter Plate must fit into the slot (F) of the Terminal Block.
- Mount the enclosed Fuse Block (C) to the Fuse Adapter Plate (B) using the 2 included machine screws.
- Connect the other side of the Jumpers (D) to the two Screw Terminals on the Fuse Block.
- Connect the primary source leads to the two Screw Terminals (E) on the Fuse Block.

FP2 Fuse Kit Contents

- 1 Fuse Adapter Plate
- 1 Two pole 13/32 x 1 1/2 Class CC, Rejection type Fuse Block
- 2 Machine Screws
- 2 Thread Forming Screws
- 2 Jumper w/Ring Terminals
- 1 Instruction Sheet

Series IC Primary Fuse Kit FP3 Type CC Fuses			
	Max. Torque In-Lbs.	Wire Size Rating	Max. Fuse Rating

Terminal Block	18	10 - 22 AWG	30 Amps @ 600 Volts
----------------	----	-------------	---------------------

Fuse Block	20	10 - 22 AWG	
------------	----	-------------	--

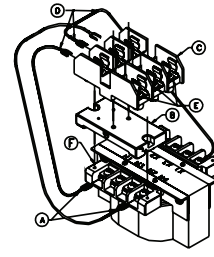

- Verify the primary jumpers are in the correct location for the desired input voltage.
- Connect one end of one of the Jumpers (A) to H1 and the other side to H4.
- Connect one side of the third lead wire to X1.
- Mount the Fuse Adapter Plate (B) to the Terminal Block using the 2 thread forming screws. The ridge on the bottom of the Fuse Adapter Plate must fit into the slot (F) of the Terminal Block.
- Mount the enclosed Fuse Block (C) to the Fuse Adapter Plate (B) using the 2 included machine screws.
- Connect the other side of the Jumpers (D) to the two Screw Terminals on the Fuse Block.
- Two will go to the primary fuse and one to the secondary fuse.
- Connect the primary source leads to the two Screw Terminals (E) on the Fuse Block.
- Connect one side of load to the secondary Fuse Block Terminal.

FP3 Fuse Kit Contents

- 1 Fuse Adapter Plate
- 1 Three pole 13/32 x 1 1/2 Class CC, Rejection type Fuse Block
- 2 Machine Screws
- 2 Thread Forming Screws
- 3 Jumper w/Ring Terminals
- 1 Instruction Sheet

Features



- All Copper Windings
- IEC type finger safe terminals
- 220°C Insulation Systems
- 50/60 Hz
- Electrostatic Shield, (earth metal screen)
- Color coded protective earth (PE) terminal
- Nonstandard designs are available by consulting the factory or your Dongan® Representative

ES Series Voltage Combinations		
Suffix	Primary	Secondary
.326	380/400/416/440/460/480/575	110/115/120
.366	380/416/480	120/24 (24 Volt load is limited to 20% of rated kVA maximum)
.376	380/400/416	110/220 115/230 120/240
.386	220/380/400/416	95/115/120

VA	Catalog Number	Catalog Number	Catalog Number	Catalog Number	Dimensions (Inches/mm)			Mounting Dimensions (Inches/mm)			Weight
					Height A	Width B	Depth C	D	E	F	
150	ES-10100.326	ES-10100.366	ES-10100.376	ES-10100.386	5.31/135	4.50/114	4.00/102	2.75/70	3.75/95	.203x.375 (5.2 x 9.5)	8
250	ES-10130.326	ES-10130.366	ES-10130.376	ES-10130.386	6.31/160	4.50/114	5.25/133	3.25/83	3.75/95	.312 x .625(7.9 x 15.9)	10
375	ES-10150.326	ES-10150.366	ES-10150.376	ES-10150.386	6.31/160	4.50/114	6.00/152	4.50/114	3.75/95	.312 x .625(7.9 x 15.9)	13
500	ES-10170.326	ES-10170.366	ES-10170.376	ES-10170.386	6.88/175	5.25/133	5.25/133	3.25/83	4.38/111	.312 x .625(7.9 x 15.9)	15
750	ES-10190.326	ES-10190.366	ES-10190.376	ES-10190.386	7.81/198	6.38/162	6.00/152	4.00/102	5.31/135	.312 x .625(7.9 x 15.9)	26
1000	ES-10200.326	ES-10200.366	ES-10200.376	ES-10200.386	7.81/198	6.38/162	6.50/165	4.50/114	5.31/135	.312 x .625(7.9 x 15.9)	30
1500	ES-10210.326	ES-10210.366	ES-10210.376	ES-10210.386	8.81/224	7.50/191	6.00/152	4.00/102	6.00/152	.312 x .625(7.9 x 15.9)	36
2000	ES-10230.326	ES-10230.366	ES-10230.376	ES-10230.386	8.81/224	7.50/191	7.00/178	5.00/127	6.00/152	.312 x .625(7.9 x 15.9)	50
3000	ES-10250.326		ES-10250.376	ES-10250.386	8.88/226	7.50/191	8.00/203	6.00/152	6.00/152	.312 x .625(7.9 x 15.9)	60
5000	ES-10300.326		ES-10300.376	ES-10300.386	10.31/262	9.00/229	9.00/229	6.50/165	6.50/165	.312 x .625(7.9 x 15.9)	90

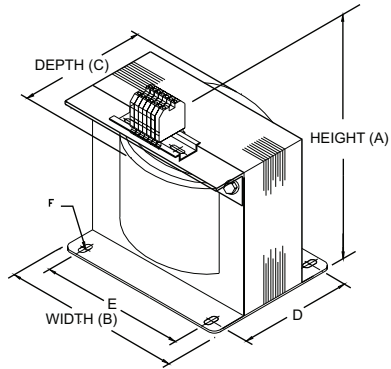

Series ES
Style of terminals may vary depending on availability.

A Certificate of Compliance is available by contacting your Dongan® Representative or the factory Customer Service Department.

Dimensions and weights may change. Consult factory for Certified Drawings.

ES Series

Suffix - .366			
Primary		Secondary	
Voltage	Connect Incoming Lines To	Secondary Voltage	Connect Load To
380	H1 & H3	24*	X1 & X3
416	H1 & H4	120	X1 & X4
480	H1 & H5		

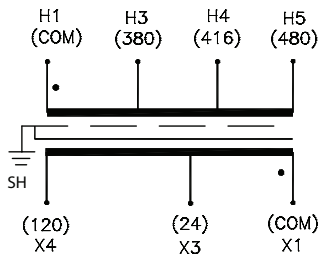

*Maximum permissible load on the 24 volt secondary is limited to 20% of the transformer's kVA. When 24 and 120 volts are used simultaneously, the total of both loads must not exceed the total transformer kVA.

Suffix - .326			
Primary		Secondary	
Voltage	Connect Incoming Lines To	Secondary Voltage	Connect Load To
380	H1 & H3	110	X1 & X3
400	H1 & H3	115	X1 & X3
416	H1 & H4	115	X1 & X4
440	H1 & H4	120	X1 & X4
460	H1 & H4	115	X1 & X3
480	H1 & H4	120	X1 & X3
575	H1 & H5	120	X1 & X4

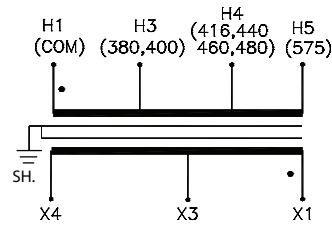

Suffix - .376				
Primary		Secondary		
Voltage	Connect Incoming Lines To	Secondary Voltage	Interconnect	Connect Load To
380	H1 & H2	110	X1 to X3	X1 & X4
400	H1 & H2	115	&	X1 & X4
416	H1 & H2	120	X2 to X4	X1 & X4
380	H1 & H2	220		X1 & X4
400	H1 & H2	230	X2 to X3	X1 & X4
416	H1 & H2	240		X1 & X4
416	H1 & H2	120/240	X2 to X3	X1 & X2/X3 & X4

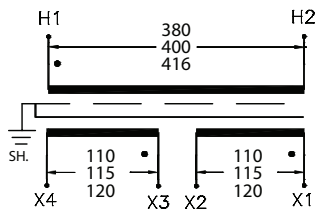

Suffix - .386			
Primary		Secondary	
Voltage	Connect Incoming Lines To	Secondary Voltage	Connect Load To
220	H1 & H3	95	X1 & X3
380	H1 & H4	115	X1 & X4
400	H1 & H5	120	X1 & X5
416	H1 & H6		

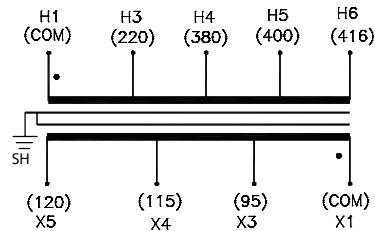

Features



- All Copper Windings
- Series/parallel jumper clips provided
- Secondary fuse kits (FKS) furnished
- All designs rated 50 / 60 Hertz up to 750 VA, 60 Hertz 1000 VA and above
- Primary fuse blocks and secondary fuse holders available



Suffix -41

Primary 240 x 480, 230 x 460, 220 x 440 - Secondary 120, 115, 110 - Triple Rated									Primary Max Amps	Secondary Max Amps
VA	Catalog Number	Weight	Dimensions (Inches/mm)			Mounting Dimensions (Inches/mm)				
			Height A	Width B	Depth C	D	E	F	240/480 V	120 V
50	HC-0050-41	3	3.25/83	3.00/76	4.75/121	2.00/51	2.50/64	.203x.375 (5.2 x 9.5)	.21/.10	.42
75	HC-0075-41	4	3.25/83	3.00/76	5.25/133	2.50/64	2.50/64	.203x.375 (5.2 x 9.5)	.31/.16	.63
100	HC-0100-41	5	3.25/83	3.00/76	5.62/143	2.87/73	2.50/64	.203x.375 (5.2 x 9.5)	.42/.21	.83
150	HC-0150-41	7	3.75/95	3.75/95	5.25/133	2.62/67	3.13/80	.203x.375 (5.2 x 9.5)	.63/.31	1.25
250	HC-0250-41	8.5	3.75/95	3.75/95	5.62/143	2.87/73	3.13/80	.203x.375 (5.2 x 9.5)	1.04/.52	2.08
300	HC-0300-41	9.5	3.75/95	3.75/95	6.00/152	3.25/83	3.13/80	.203x.375 (5.2 x 9.5)	1.25/.63	2.50
375	HC-0375-41	10	4.25/108	4.50/114	5.50/140	2.75/70	3.75/95	.203x.375 (5.2 x 9.5)	1.56/.78	3.13
500	HC-0500-41	11.5	4.25/108	4.50/114	6.00/142	3.25/83	3.75/95	.203x.375 (5.2 x 9.5)	2.08/1.04	4.17
750	HC-0750-41	15.5	4.25/108	4.50/114	6.87/175	4.12/105	3.75/95	.203x.375 (5.2 x 9.5)	3.12/1.56	6.25
1000	HC-1000-41	19	4.87/124	5.25/133	6.50/165	3.87/98	4.37/111	.281x562 (7.1 x 14.3)	4.16/2.08	8.33
1500	HC-1500-41	27	4.87/124	5.25/133	7.87/200	5.12/130	4.37/111	.281x562 (7.1 x 14.3)	6.25/3.12	12.50
2000	HC-2000-41	32	4.87/124	5.25/133	9.12/232	6.40/163	4.37/111	.281x562 (7.1 x 14.3)	8.33/4.16	16.67

Suffix -44

Primary 208 / 240 / 480 - Secondary 120									Primary Max Amps	Secondary Max Amps
VA	Catalog Number	Weight	Dimensions (Inches/mm)			Mounting Dimensions (Inches/mm)				
			Height A	Width B	Depth C	D	E	F	208/240/480 V	120 V
50	HC-0050-44	3	3.25/83	3.00/76	5.00/127	2.25/57	2.50/64	.203x.375 (5.2 x 9.5)	.24/.21/.10	.42
75	HC-0075-44	4	3.25/83	3.00/76	5.62/143	2.87/73	2.50/64	.203x.375 (5.2 x 9.5)	.36/.31/.16	.63
100	HC-0100-44	5.5	3.75/95	3.75/95	5.25/133	2.50/64	3.13/80	.203x.375 (5.2 x 9.5)	.48/.42/.21	.83
150	HC-0150-44	7.5	3.75/95	3.75/95	6.12/155	3.31/84	3.13/80	.203x.375 (5.2 x 9.5)	.72/.63/.31	1.25
250	HC-0250-44	8.5	4.30/1.09	4.50/114	5.25/133	2.50/64	3.75/95	.203x.375 (5.2 x 9.5)	1.21/1.04/.52	2.08
300	HC-0300-44	10.5	4.30/1.09	4.50/114	6.00/152	3.25/83	3.75/95	.203x.375 (5.2 x 9.5)	1.4/1.25/.63	2.50
375	HC-0375-44	11.5	4.30/1.09	4.50/114	6.00/152	3.25/83	3.75/95	.203x.375 (5.2 x 9.5)	1.8/1.56/.78	3.13
500	HC-0500-44	13.5	4.30/1.09	4.50/114	6.50/165	3.75/95	3.75/95	.203x.375 (5.2 x 9.5)	2.4/2.08/1.04	4.17
750	HC-0750-44	18.5	4.87/124	5.25/133	6.50/165	3.75/95	4.37/111	.203x.375 (5.2 x 9.5)	3.6/3.12/1.56	6.25
1000	HC-1000-44	20	4.87/124	5.25/133	6.75/171	4.00/102	4.37/111	.281x562 (7.1 x 14.3)	4.8/4.16/2.08	8.33
1500	HC-1500-44	29.5	4.87/124	5.25/133	8.50/216	5.87/149	4.37/111	.281x562 (7.1 x 14.3)	7.2/6.25/3.12	12.50
2000	HC-2000-44	32	6.25/159	4.25/108	8.50/216	5.93/151	3.43/87	.281x562 (7.1 x 14.3)	9.6/8.33/4.16	16.67

Suffix -46

Primary 600/575/550 - Secondary 120, 115, 110 - Triple Rated									Primary Max Amps	Secondary Max Amps
VA	Catalog Number	Weight lbs	Dimensions (Inches/mm)			Mounting Dimensions (Inches/mm)				
			Height A	Width B	Depth C	D	E	F	600 V	120 V
50	HC-0050-46	3	3.25/83	3.00/76	4.75/121	2.00/51	2.50/64	.203x.375 (5.2 x 9.5)	.08	.42
75	HC-0075-46	4	3.25/83	3.00/76	5.25/133	2.50/64	2.50/64	.203x.375 (5.2 x 9.5)	.13	.63
100	HC-0100-46	5	3.25/83	3.00/76	5.62/143	2.87/73	2.50/64	.203x.375 (5.2 x 9.5)	.17	.83
150	HC-0150-46	7	3.75/95	3.75/95	5.25/133	2.62/67	3.13/80	.203x.375 (5.2 x 9.5)	.25	1.25
250	HC-0250-46	8.5	3.75/95	3.75/95	5.62/143	2.87/73	3.13/80	.203x.375 (5.2 x 9.5)	.42	2.08
300	HC-0300-	9.5	3.75/95	3.75/95	6.00/142	3.25/83	3.13/80	.203x.375 (5.2 x 9.5)	.50	2.50
375	HC-0375-46	10	4.2/107	4.50/114	5.30/135	2.75/70	3.75/95	.203x.375 (5.2 x 9.5)	.63	3.13
500	HC-0500-46	11.5	4.25/108	4.50/114	6.00/142	3.25/83	3.75/95	.203x.375 (5.2 x 9.5)	.83	4.17
750	HC-0750-46	15.5	4.25/108	4.50/114	6.87/175	4.12/105	3.75/95	.203x.375 (5.2 x 9.5)	1.3	6.25
1000	HC-1000-46	19	4.87/124	5.25/133	6.50/165	3.87/98	4.37/111	.281x562 (7.1 x 14.3)	1.7	8.33
1500	HC-1500-46	27	4.87/124	5.25/133	7.87/200	5.12/130	4.37/111	.281x562 (7.1 x 14.3)	2.5	12.50
2000	HC-2000-46	32	4.87/124	5.25/133	9.12/232	6.40/163	4.37/111	.281x562 (7.1 x 14.3)	3.3	16.67

Suffix -47

Primary 240/480/600, 230/460/575, 220/440/550 - Secondary 120/115/110 Triple Rated									Primary Max Amps	Secondary Max Amps
VA	Catalog Number	Weight lbs	Dimensions (Inches/mm)			Mounting Dimensions (Inches/mm)				
			Height A	Width B	Depth C	D	E	F	208/240/480 V	120 V
50	HC-0050-47	3	3.25/83	3.00/76	5.00/127	2.25/57	2.50/64	.203x.375 (5.2 x 9.5)	.21/.10/.08	.42
75	HC-0075-47	4	3.25/83	3.00/76	5.62/143	2.87/73	2.50/64	.203x.375 (5.2 x 9.5)	.31/.16/.13	.63
100	HC-0100-47	5.5	3.75/95	3.75/95	5.25/133	2.50/64	3.13/80	.203x.375 (5.2 x 9.5)	.42/.21/.17	.83
150	HC-0150-47	7.5	3.75/95	3.75/95	6.12/155	3.31/84	3.13/80	.203x.375 (5.2 x 9.5)	.63/.31/.25	1.25
250	HC-0250-47	8.5	4.30/1.09	4.50/114	5.25/133	2.50/64	3.75/95	.203x.375 (5.2 x 9.5)	1.04/.52/.42	2.08
300	HC-0300-47	10.5	4.30/1.09	4.50/114	6.00/152	3.25/83	3.75/95	.203x.375 (5.2 x 9.5)	1.25/.63/.50	2.50
375	HC-0375-47	11.5	4.30/1.09	4.50/114	6.00/152	3.25/83	3.75/95	.203x.375 (5.2 x 9.5)	1.56/.78/.63	3.13
500	HC-0500-47	13.5	4.30/1.09	4.50/114	6.50/165	3.75/95	3.75/95	.203x.375 (5.2 x 9.5)	2.08/1.04/.83	4.17
750	HC-0750-47	18.5	4.87/124	5.25/133	6.50/165	3.75/95	4.37/111	.203x.375 (5.2 x 9.5)	3.1/1.6/1.3	6.25
1000	HC-1000-47	20	4.87/124	5.25/133	6.75/171	4.00/102	4.37/111	.281x562 (7.1 x 14.3)	4.16/2.08/1.7	8.33
1500	HC-1500-47	29.5	4.87/124	5.25/133	8.50/216	5.87/149	4.37/111	.281x562 (7.1 x 14.3)	6.25/3.12/2.5	12.50
2000	HC-2000-47	32	6.25/159	4.25/108	8.50/216	5.93/151	3.43/87	.281x562 (7.1 x 14.3)	8.33/4.16/3.3	16.67

Suffix -4100

Features Pre-Connected Dual Primary Fuse Blocks

Primary 240 x 480, 230 x 460, 220 x 440 - Secondary 120, 115, 110 - Triple Rated									Primary Max Amps	Secondary Max Amps
VA	Catalog Number	Weight lbs	Dimensions (Inches/mm)			Mounting Dimensions (Inches/mm)				
			Height A	Width B	Depth C	D	E	F	240/480 V	120 V
50	HC-0050-4100	3	4.25/108	3.00/76	4.75/121	2.00/51	2.50/64	.203x.375 (5.2 x 9.5)	.21/.10	.42
75	HC-0075-4100	4	4.25/108	3.00/76	5.25/133	2.50/64	2.50/64	.203x.375 (5.2 x 9.5)	.31/.16	.63
100	HC-0100-4100	5	4.25/108	3.00/76	5.62/143	2.87/73	2.50/64	.203x.375 (5.2 x 9.5)	.42/.21	.83
150	HC-0150-4100	7	4.75/121	3.75/95	5.25/133	2.62/67	3.13/80	.203x.375 (5.2 x 9.5)	.63/.31	1.25
250	HC-0250-4100	8.5	4.75/121	3.75/95	5.62/143	2.87/73	3.13/80	.203x.375 (5.2 x 9.5)	1.04/.52	2.08
300	HC-0300-4100	9.5	4.75/121	3.75/95	6.00/152	2.87/73	3.13/80	.203x.375 (5.2 x 9.5)	1.25/.63	2.50
375	HC-0375-4100	10	5.30/135	4.50/114	5.50/140	2.75/70	3.75/95	.203x.375 (5.2 x 9.5)	1.56/.78	3.13
500	HC-0500-4100	11.5	5.25/133	4.50/114	6.00/142	3.25/83	3.75/95	.203x.375 (5.2 x 9.5)	2.08/1.04	4.17
750	HC-0750-4100	15.5	5.25/133	4.50/114	6.87/175	4.12/105	3.75/95	.203x.375 (5.2 x 9.5)	3.12/1.56	6.25
1000	HC-1000-4100	19	5.87/149	5.25/133	6.50/165	3.87/98	4.37/111	.281x562 (7.1 x 14.3)	4.16/2.08	8.33
1500	HC-1500-4100	27	5.87/149	5.25/133	7.87/200	5.12/130	4.37/111	.281x562 (7.1 x 14.3)	6.25/3.12	12.50
2000	HC-2000-4100	32	5.87/149	5.25/133	9.12/232	6.40/163	4.37/111	.281x562 (7.1 x 14.3)	8.33/4.16	16.67

Dimensions and weights may change. Consult factory for Certified Drawings.

Suffix -4400

Features Pre-Connected Dual Primary Fuse Blocks

Primary 208 / 240 / 480 - Secondary 120									Primary Max Amps	Secondary Max Amps
VA	Catalog Number	Weight lbs	Dimensions (Inches/mm)			Mounting Dimensions (Inches/mm)				
			Height A	Width B	Depth C	D	E	F	208/240/480 V	120 V
50	HC-0050-4400	3	4.25/108	3.00/76	5.00/127	2.25/57	2.50/64	.203x.375 (5.2 x 9.5)	.24/.21/.10	.42
75	HC-0075-4400	4	4.25/108	3.00/76	5.62/143	2.87/73	2.50/64	.203x.375 (5.2 x 9.5)	.36/.31/.16	.63
100	HC-0100-4400	5.5	4.75/121	3.75/95	5.25/133	2.50/64	3.13/80	.203x.375 (5.2 x 9.5)	.48/.42/.21	.83
150	HC-0150-4400	7.5	4.75/121	3.75/95	6.12/155	3.31/84	3.13/80	.203x.375 (5.2 x 9.5)	.72/.63/.31	1.25
250	HC-0250-4400	8.5	5.50/140	4.50/114	5.25/133	2.50/64	3.75/95	.203x.375 (5.2 x 9.5)	1.21/1.04/.52	2.08
300	HC-0300-4400	10.5	5.50/140	4.50/114	6.00/152	3.25/83	3.75/95	.203x.375 (5.2 x 9.5)	1.4/1.25/.63	2.50
375	HC-0375-4400	11.5	5.50/140	4.50/114	6.00/152	3.25/83	3.75/95	.203x.375 (5.2 x 9.5)	1.8/1.56/.78	3.13
500	HC-0500-4400	13.5	5.50/140	4.50/114	6.50/165	3.75/95	3.75/95	.203x.375 (5.2 x 9.5)	2.4/2.08/1.04	4.17
750	HC-0750-4400	18.5	6.25/159	5.25/133	6.50/165	3.75/95	4.37/111	.203x.375 (5.2 x 9.5)	3.6/3.12/1.56	6.25
1000	HC-1000-4400	20	6.25/159	5.25/133	6.75/171	4.00/102	4.37/111	.281x562 (7.1 x 14.3)	4.8/4.16/2.08	8.33
1500	HC-1500-4400	29.5	6.25/159	5.25/133	8.50/216	5.87/149	4.37/111	.281x562 (7.1 x 14.3)	7.2/6.25/3.12	12.50
2000	HC-2000-4400	32	5.25/133	4.25/108	8.50/216	5.93/151	3.43/87	.281x562 (7.1 x 14.3)	9.6/8.33/4.16	16.67

Series HC Primary Fuse Kit Installation

Fuse Kit FKP2

- Meets UL 508
- Meets NEC Article 450
- Uses Class CC Fuses

Installation Procedure

- Locate the mounting hole in the terminal block of primary side of transformer.
- Fasten FKP2 Fuse Holder to primary side of transformer terminal block with the screw provided.
- Connect the Fuse Holder leads to the transformer terminals with the jumper leads furnished.

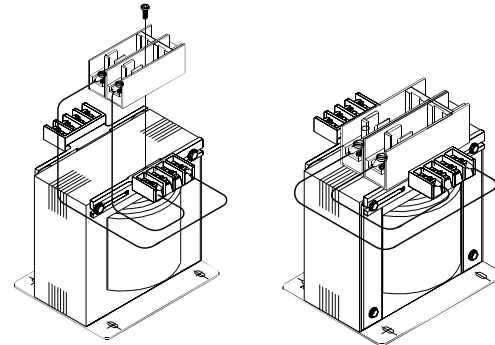

Series HC Recommended Fuse Type by Manufacturer

Manufacturer	Bussman	Goold	Littlefuse
Primary Fuse Type	FNQ-R	ATQR / ATDR	KLDR / CCRM
Secondary Fuse Type	FNM / FNQ (250V) (500V)	TRM / ATQ (250V) (500V)	FLM / FLQ (250V) (500V)

Note: Fuses sold separately.

Series HC Secondary Fuse Kit Installation

Fuse Kit FKS

Installation Procedure

- To fuse Terminal X1, remove #10 screws in Terminals X1, XF, and unmarked terminal slot.
- Fasten Fuse Clip to transformer Terminal X1 using a #10 screw.
- Fasten a #10 screw through Fuse Clip and Jumper Terminal and into unmarked Terminal slot.
- Fasten #10 screw through Jumper Terminal and into Terminal XF.
- Connect load to terminals X2 and XF.

Secondary Fuse Kit FKS Furnished with each Transformer

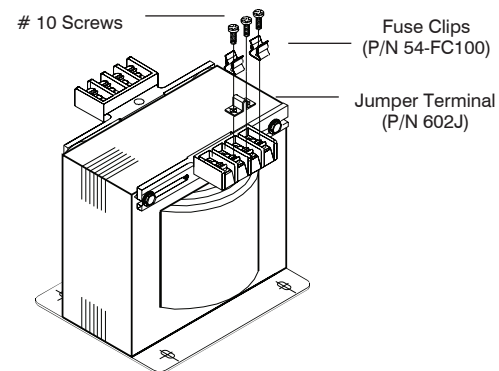

Note: Fuses sold separately.

Dimensions and weights may change. Consult factory for Certified Drawings.

Series HC are shipped with Jumper Clips connected in Series

Jumpers shown stacked for Series Connections

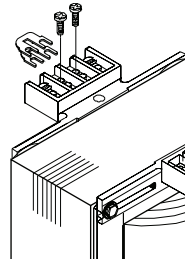

Jumpers shown spread for Parallel Connections

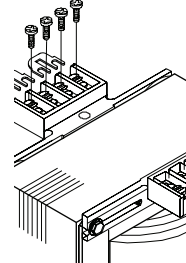

Suffix -41				
Primary		Connect Incoming Lines To	Secondary	
Voltage	Jumper		Voltage	Connect Load To
240	H1 to H3	H1 & H4	120	X1 & X2
230 & 220	H2 to H4			
480	H2 to H3	H1 & H4	115	X1 & X2
460			110	
440				

Suffix -44				
Primary		Connect Incoming Lines To	Secondary	
Voltage	Jumper		Voltage	Connect Load To
208	-	H1 & H2		
240	-	H1 & H3	120	X1 & X2
480	-	H1 & H4		

Suffix -46				
Primary		Connect Incoming Lines To	Secondary	
Voltage	Jumper		Voltage	Connect Load To
600	-	H1 & H2	120	X1 & X2

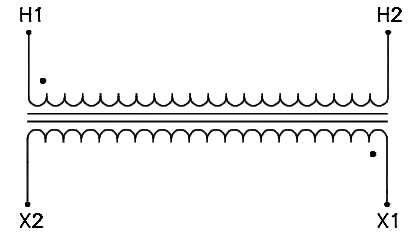
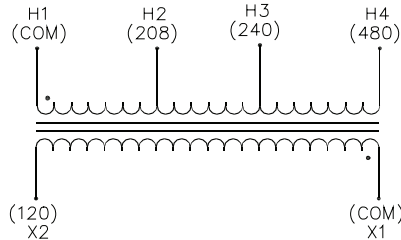
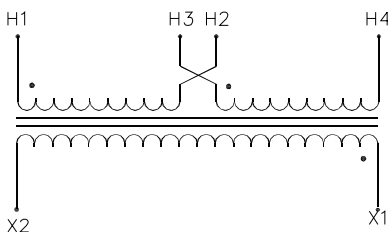

Suffix -47				
Primary		Connect Incoming Lines To	Secondary	
Voltage	Jumper		Voltage	Connect Load To
240	-	H1 & H2		
480	-	H1 & H3	120	X1 & X2
600	-	H1 & H4		

Suffix -4100				
Primary		Connect Incoming Lines To	Secondary	
Voltage	Jumper		Voltage	Connect Load To
240	H1 to H3	H1 & H4	120	XF & X2
230 & 220	H2 to H4			
480	H2 to H3	H1 & H4	115	XF & X2
460			110	
440				

Suffix -4400				
Primary		Connect Incoming Lines To	Secondary	
Voltage	Jumper		Voltage	Connect Load To
208	-	H1 & H2		
240	-	H1 & H3	120	XF & X2
480	-	H1 & H4		

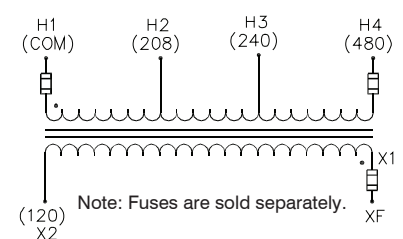
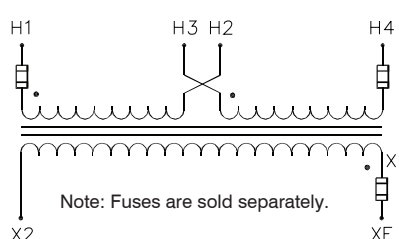
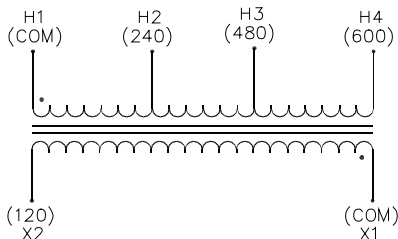

Features



- All Copper Windings
- All designs rated 50 / 60 Hertz
- Primary fuse blocks and secondary fuse holders available



Suffix -052

Primary 120 x 240 - Secondary 24									Primary Max Amps	Secondary Max Amps
VA	Catalog Number	Weight lbs	Dimensions (Inches/mm)			Mounting Dimensions (Inches/mm)				
			Height A	Width B	Depth C	D	E	F	120/240 V	24 V
50	50-0050-052	3	2.50/64	3.00/76	3.00/76	2.00/51	2.50/64	.203x.375 (5.2 x 9.5)	.42/21	2.08
75	50-0075-052	3	2.50/64	3.00/76	3.38/86	2.50/64	2.50/64	.203x.375 (5.2 x 9.5)	.63/31	3.13
100	50-0100-052	4	2.81/71	3.38/86	3.38/86	2.38/60	2.81/71	.203x.375 (5.2 x 9.5)	.83/42	4.17
150	50-0150-052	6	3.13/80	3.75/95	3.90/99	2.63/67	3.13/80	.203x.375 (5.2 x 9.5)	1.25/.63	6.25
200	50-0200-052	8	3.75/95	4.50/114	4.12/105	2.50/64	3.75/95	.203x.375 (5.2 x 9.5)	1.67/.83	8.33
250	50-0250-052	9	3.75/95	4.50/114	4.25/108	2.75/70	3.75/95	.203x.375 (5.2 x 9.5)	2.08/1.04	10.42
300	50-0300-052	11	3.75/95	4.50/114	4.75/121	3.13/80	3.75/95	.203x.375 (5.2 x 9.5)	2.50/1.25	12.50
375	50-0375-052	12	3.75/95	4.50/114	5.25/133	3.63/92	3.75/95	.203x.375 (5.2 x 9.5)	3.13/1.56	15.63
500	50-0500-052	17	4.38/111	5.25/133	5.88/149	3.63/92	4.38/111	.281x562 (7.1 x 14.3)	4.17/2.08	20.83
750	50-0750-052	25	4.38/111	5.25/133	7.50/191	5.25/133	4.38/111	.281x562 (7.1 x 14.3)	6.25/3.13	31.25
1000	50-1000-052	26	4.38/111	5.25/133	7.50/191	5.25/133	4.38/111	.281x562 (7.1 x 14.3)	8.33/4.17	41.67

Suffix -053

Primary 240 x 480, 230 x 460, 220 x 440 - Secondary 120, 115, 110 - Triple Rated									Primary Max Amps	Secondary Max Amps
VA	Catalog Number	Weight lbs	Dimensions (Inches/mm)			Mounting Dimensions (Inches/mm)				
			Height A	Width B	Depth C	D	E	F	240/480 V	120 V
50	50-0050-053	3	2.50/64	3.00/76	3.00/76	2.00/51	2.50/64	.203x.375 (5.2 x 9.5)	.21/.10	.42
75	50-0075-053	3	2.50/64	3.00/76	3.38/86	2.50/64	2.50/64	.203x.375 (5.2 x 9.5)	.31/.16	.63
100	50-0100-053	4	2.81/71	3.38/86	3.38/86	2.38/60	2.81/71	.203x.375 (5.2 x 9.5)	.42/.21	.83
150	50-0150-053	6	3.13/80	3.75/95	3.90/99	2.63/67	3.13/80	.203x.375 (5.2 x 9.5)	.63/.31	1.25
200	50-0200-053	8	3.75/95	4.50/114	4.12/105	2.50/64	3.75/95	.203x.375 (5.2 x 9.5)	.83/.42	1.67
250	50-0250-053	9	3.75/95	4.50/114	4.25/108	2.75/70	3.75/95	.203x.375 (5.2 x 9.5)	1.04/.52	2.08
300	50-0300-053	11	3.75/95	4.50/114	4.75/121	3.13/80	3.75/95	.203x.375 (5.2 x 9.5)	1.25/.63	2.50
375	50-0375-053	12	3.75/95	4.50/114	5.25/133	3.63/92	3.75/95	.203x.375 (5.2 x 9.5)	1.56/.78	3.13
500	50-0500-053	17	4.38/111	5.25/133	5.88/149	3.63/92	4.38/111	.281x562 (7.1 x 14.3)	2.08/1.04	4.17
750	50-0750-053	25	4.38/111	5.25/133	7.50/191	5.25/133	4.38/111	.281x562 (7.1 x 14.3)	3.13/1.56	6.25
1000	50-1000-053	26	4.38/111	5.25/133	7.50/191	5.25/133	4.38/111	.281x562 (7.1 x 14.3)	4.17/2.08	8.33
1500	50-1500-053	32	5.62/143	6.38/162	7.00/178	4.50/114	5.31/135	.312x.625 (7.9 x 15.9)	6.25/3.13	12.50
2000	50-2000-053	38	5.62/143	6.38/162	7.62/194	5.00/127	5.31/135	.312x.625 (7.9 x 15.9)	8.33/4.17	16.67
3000	50-3000-053	50	6.62/168	7.50/191	7.75/197	4.75/121	6.75/171	.312x.625 (7.9 x 15.9)	12.50/6.25	25.00
5000	50-5000-053	70	6.62/168	7.5/191	10.25/	6.88/	6.75/171	.312x.625 (7.9 x 15.9)	20.83/10.42	41.67

Dimensions and weights may change. Consult factory for Certified Drawings.

Suffix -054

Primary 208 - Secondary 120									Primary Max Amps	Secondary Max Amps
VA	Catalog Number	Weight lbs	Dimensions (Inches/mm)			Mounting Dimensions (Inches/mm)				
			Height A	Width B	Depth C	D	E	F	208 V	120 V
50	50-0050-054	3	2.50/64	3.00/76	3.00/76	2.00/51	2.50/64	.203x.375 (5.2 x 9.5)	.24	.42
75	50-0075-054	3	2.50/64	3.00/76	3.38/86	2.50/64	2.50/64	.203x.375 (5.2 x 9.5)	.36	.63
100	50-0100-054	4	2.81/71	3.38/86	3.38/86	2.38/60	2.81/71	.203x.375 (5.2 x 9.5)	.48	.83
150	50-0150-054	6	3.13/80	3.75/95	3.90/99	2.63/67	3.13/80	.203x.375 (5.2 x 9.5)	.72	1.25
200	50-0200-054	8	3.75/95	4.50/114	4.12/105	2.50/64	3.75/95	.203x.375 (5.2 x 9.5)	.96	1.67
250	50-0250-054	9	3.75/95	4.50/114	4.25/108	2.75/70	3.75/95	.203x.375 (5.2 x 9.5)	1.20	2.08
300	50-0300-054	11	3.75/95	4.50/114	4.75/121	3.13/80	3.75/95	.203x.375 (5.2 x 9.5)	1.44	2.50
375	50-0375-054	12	3.75/95	4.50/114	5.25/133	3.63/92	3.75/95	.203x.375 (5.2 x 9.5)	1.80	3.13
500	50-0500-054	17	4.38/111	5.25/133	5.88/149	3.63/92	4.38/111	.281x562 (7.1 x 14.3)	2.40	4.17
750	50-0750-054	25	4.38/111	5.25/133	7.50/191	5.25/133	4.38/111	.281x562 (7.1 x 14.3)	3.61	6.25
1000	50-1000-054	26	4.38/111	5.25/133	7.50/191	5.25/133	4.38/111	.281x562 (7.1 x 14.3)	4.81	8.33
1500	50-1500-054	32	5.62/143	6.38/162	7.00/178	4.50/114	5.31/135	.312x.625 (7.9 x 15.9)	7.21	12.50
2000	50-2000-054	38	5.62/143	6.38/162	7.62/194	5.00/127	5.31/135	.312x.625 (7.9 x 15.9)	9.62	16.67
3000	50-3000-054	50	6.62/168	7.50/191	7.75/197	4.75/121	6.75/171	.312x.625 (7.9 x 15.9)	14.42	25.00

Suffix -056

Primary 600/575/550 - Secondary 120/115/110 Triple Rated									Primary Max Amps	Secondary Max Amps
VA	Catalog Number	Weight lbs	Dimensions (Inches/mm)			Mounting Dimensions (Inches/mm)				
			Height A	Width B	Depth C	D	E	F	600 V	120 V
50	50-0050-056	3	2.50/64	3.00/76	3.00/76	2.00/51	2.50/64	.203x.375 (5.2 x 9.5)	.08	.42
75	50-0075-056	3	2.50/64	3.00/76	3.38/86	2.50/64	2.50/64	.203x.375 (5.2 x 9.5)	.13	.63
100	50-0100-056	4	2.81/71	3.38/86	3.38/86	2.38/60	2.81/71	.203x.375 (5.2 x 9.5)	.17	.83
150	50-0150-056	6	3.13/80	3.75/95	3.90/99	2.63/67	3.13/80	.203x.375 (5.2 x 9.5)	.25	1.25
200	50-0200-056	8	3.75/95	4.50/114	4.12/105	2.50/64	3.75/95	.203x.375 (5.2 x 9.5)	.33	1.67
250	50-0250-056	9	3.75/95	4.50/114	4.25/108	2.75/70	3.75/95	.203x.375 (5.2 x 9.5)	.42	2.08
300	50-0300-056	11	3.75/95	4.50/114	4.75/121	3.13/80	3.75/95	.203x.375 (5.2 x 9.5)	.50	2.50
375	50-0375-056	12	3.75/95	4.50/114	5.25/133	3.63/92	3.75/95	.203x.375 (5.2 x 9.5)	.63	3.13
500	50-0500-056	17	4.38/111	5.25/133	5.88/149	3.63/92	4.38/111	.281x562 (7.1 x 14.3)	.83	4.17
750	50-0750-056	25	4.38/111	5.25/133	7.50/191	5.25/133	4.38/111	.281x562 (7.1 x 14.3)	1.25	6.25
1000	50-1000-056	26	4.38/111	5.25/133	7.50/191	5.25/133	4.38/111	.281x562 (7.1 x 14.3)	1.67	8.33
1500	50-1500-056	32	5.62/143	6.38/162	7.00/178	4.50/114	5.31/135	.312x.625 (7.9 x 15.9)	2.50	12.50
2000	50-2000-056	38	5.62/143	6.38/162	7.62/194	5.00/127	5.31/135	.312x.625 (7.9 x 15.9)	3.33	16.67
3000	50-3000-056	50	6.62/168	7.50/191	7.75/197	4.75/121	6.75/171	.312x.625 (7.9 x 15.9)	5.00	25.00

Suffix -058

Primary 220/380/415 - Secondary 95/115									Primary Max Amps	Secondary Max Amps
VA	Catalog Number	Weight lbs	Dimensions (Inches/mm)			Mounting Dimensions (Inches/mm)				
			Height A	Width B	Depth C	D	E	F	220/380/415 V	95/115 V
250	50-0250-058	11	3.75/95	4.50/114	4.81/122	3.38/86	3.75/95	.203x.375 (5.2 x 9.5)	1.14/1.66/60	2.63/2.17
500	50-0500-058	22	4.38/111	5.25/133	6.63/168	4.60/117	4.38/111	.281x562 (7.1 x 14.3)	2.27/1.32/1.20	5.26/4.35
750	50-0750-058	23	4.25/108	5.75/146	7.38/187	4.38/111	4.94/125	.281x562 (7.1 x 14.3)	3.41/1.97/1.81	7.89/6.52
1000	50-1000-058	32	5.31/135	6.38/162	6.75/171	4.50/114	5.31/135	.312x.625 (7.9 x 15.9)	4.5/2.6/2.4	10.5/8.7
1500	50-1500-058	41	6.25/159	7.50/191	6.25/159	4.00/102	6.75/171	.312x.625 (7.9 x 15.9)	6.8/3.9/3.6	15.7/13.0
2000	50-2000-058	49	6.25/159	7.50/191	7.80/198	4.75/121	6.75/171	.312x.625 (7.9 x 15.9)	9.0/5.2/4.8	21.0/17.3
3000	50-3000-058	75	6.25/159	7.50/191	9.88/251	6.88/175	6.75/171	.312x.625 (7.9 x 15.9)	13.6/7.8/7.2	31.5/26.0
5000	50-5000-058	113	7.50/191	9.00/229	9.12/232	6.93/176	7.50/191	.437x.750 (111 x 19.1)	22.7/13.1/12.0	52.6/43.4

Dimensions and weights may change. Consult factory for Certified Drawings.

Suffix -059

Primary - Secondary 208/500 - 85/100/110 220/380/440/550 - 91/110/120 230/400/460/575 - 95/115/125 240/416/480/600 - 99/120/130									Secondary Amps
VA	Catalog Number	Weight lbs	Dimensions (Inches/mm)			Mounting Dimensions (Inches/mm)			120 V
			Height A	Width B	Depth C	D	E	F	
150	50-0150-059	11	4.38/111	5.25/133	4.57/116	2.63/	4.38/111	.281x562 (7.1 x 14.3)	1.25
250	50-0150-059	15	4.38/111	5.25/133	5.25/133	3.38/86	4.38/111	.281x562 (7.1 x 14.3)	2.25
375	50-0375-059	18	4.25/108	5.75/146	6.25/159	3.44/	4.94/	.281x562 (7.1 x 14.3)	3.2
500	50-0500-059	22	4.25/108	5.75/146	6.68/	4.38/111	4.94/	.281x562 (7.1 x 14.3)	4.5
750	50-0750-059	32	5.31/135	6.38/162	6.75/170	4.50/114	5.31/135	.312x.625 (7.9 x 15.9)	6.25
1000	50-1000-059	35	5.31/135	6.38/162	7.25/	5.00/	5.31/135	.312x.625 (7.9 x 15.9)	9
1500	50-1500-059	53	6.25/159	7.50/191	8.63/	5.25/	6.75/171	.312x.625 (7.9 x 15.9)	15
2000	50-2000-059	60	6.25/159	7.50/191	8.75/	5.80/	6.75/171	.312x.625 (7.9 x 15.9)	20
3000	50-3000-059	74	6.25/159	7.50/191	10.25/	6.88/	6.75/171	.312x.625 (7.9 x 15.9)	25

Suffix -134

Primary 240 x 480, 230 x 460, 220 x 440 - Secondary 120/240, 115/230, 110/220 - Triple Rated									Primary Max Amps	Secondary Max Amps
VA	Catalog Number	Weight lbs	Dimensions (Inches/mm)			Mounting Dimensions (Inches/mm)			240/480 V	120/240 V
			Height A	Width B	Depth C	D	E	F		
50	50-0050-134	3	2.50/64	3.00/76	3.00/76	2.00/51	2.50/64	.203x.375 (5.2 x 9.5)	.21/.10	.42/21
75	50-0075-134	3	2.50/64	3.00/76	3.38/86	2.50/64	2.50/64	.203x.375 (5.2 x 9.5)	.31/.16	.63/.31
100	50-0100-134	4	2.81/71	3.38/86	3.38/86	2.38/60	2.81/71	.203x.375 (5.2 x 9.5)	.42/.21	.83/.42
150	50-0150-134	6	3.13/80	3.75/95	3.90/99	2.63/67	3.13/80	.203x.375 (5.2 x 9.5)	.63/.31	1.25/.63
200	50-0200-134	8	3.75/95	4.50/114	4.12/105	2.50/64	3.75/95	.203x.375 (5.2 x 9.5)	.83/.42	1.67/.83
250	50-0250-134	9	3.75/95	4.50/114	4.25/108	2.75/70	3.75/95	.203x.375 (5.2 x 9.5)	1.04/.52	2.08/1.04
300	50-0300-134	11	3.75/95	4.50/114	4.75/121	3.13/80	3.75/95	.203x.375 (5.2 x 9.5)	1.25/.63	2.50/1.25
375	50-0375-134	12	3.75/95	4.50/114	5.25/133	3.63/92	3.75/95	.203x.375 (5.2 x 9.5)	1.56/.78	3.13/1.56
500	50-0500-134	17	4.38/111	5.25/133	5.88/149	3.63/92	4.38/111	.281x562 (7.1 x 14.3)	2.08/1.04	4.17/2.08
750	50-0750-134	25	4.38/111	5.25/133	7.50/191	5.25/133	4.38/111	.281x562 (7.1 x 14.3)	3.13/1.56	6.25/3.13
1000	50-1000-134	26	4.38/111	5.25/133	7.50/191	5.25/133	4.38/111	.281x562 (7.1 x 14.3)	4.17/2.08	8.33/4.17
1500	50-1500-134	32	5.62/143	6.38/162	7.00/178	4.50/114	5.31/135	.312x.625 (7.9 x 15.9)	6.25/3.13	12.50/6.25
2000	50-2000-134	38	5.62/143	6.38/162	7.62/194	5.00/127	5.31/135	.312x.625 (7.9 x 15.9)	8.33/4.17	16.67/8.33
3000	50-3000-134	50	6.62/168	7.50/191	7.75/197	4.75/121	6.75/171	.312x.625 (7.9 x 15.9)	12.50/6.25	25.00/12.50

Dimensions and weights may change. Consult factory for Certified Drawings.

50 Series

Suffix -052				
Primary			Secondary	
Voltage	Jumper	Connect Incoming Lines To	Voltage	Connect Load To
120	H1 to H3 & H2 to H4	H1 & H4	24	X1 & X2
240	H2 to H3	H1 & H4		

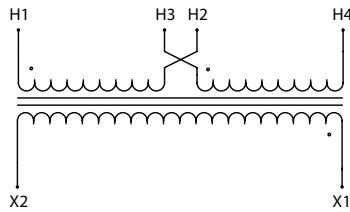

Suffix -053				
Primary			Secondary	
Voltage	Jumper	Connect Incoming Lines To	Voltage	Connect Load To
240	H1 to H3 & H2 to H4	H1 & H4	120	X1 & X2
230		H1 & H4	115	X1 & X2
220		H1 & H4	110	
480	H2 to H3	H1 & H4		
460		H1 & H4		
440		H1 & H4		

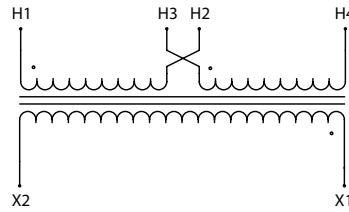

Suffix -054				
Primary			Secondary	
Voltage	Jumper	Connect Incoming Lines To	Voltage	Connect Load To
208	-	H1 & H2	120	X1 & X2

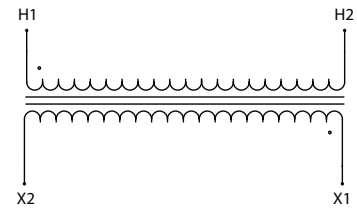

Suffix -056				
Primary			Secondary	
Voltage	Jumper	Connect Incoming Lines To	Voltage	Connect Load To
600	-	H1 & H2	120	X1 & X2
575			115	X1 & X2
550			110	X1 & X2

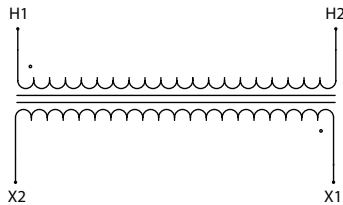

Suffix -058				
Primary			Secondary	
Voltage	Jumper	Connect Incoming Lines To	Voltage	Connect Load To
220	-	H1 & H2	95	X1 & X2
380	-	H1 & H3		
415	-	H1 & H4	115	X1 & X3

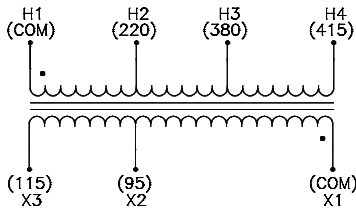

Suffix -134					
0.45			Secondary		
Voltage	Jumper	Connect Incoming Lines To	Voltage	Jumper	Connect Load To
240	H1 to H3 & H2 to H4	H1 & H4	120	X1 to X3 & X2 to X4	X1 & X4
230		H1 & H4	115		X1 & X4
220		H1 & H4	110		X1 & X4
480	H2 to H3	H1 & H4	120	X1 to X3 & X2 to X4	X1 & X4
460		H1 & H4	115		X1 & X4
440		H1 & H4	110		X1 & X4
240	H1 to H3 & H2 to H4	H1 & H4	240	X2 to X3	X1 & X4
230		H1 & H4	230		X1 & X4
220		H1 & H4	220		X1 & X4
480	H2 to H3	H1 & H4	240	X2 to X3	X1 & X4
460		H1 & H4	230		X1 & X4
440		H1 & H4	220		X1 & X4

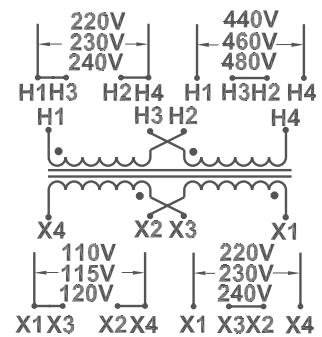

Suffix -059						
Primary				Secondary		
Connect Incoming Lines To H1 & H2	Connect Incoming Lines To H1 & H3	Connect Incoming Lines To H1 & H4	Connect Incoming Lines To H1 & H5	Connect Load To X1 & X2	Connect Load To X1 & X3	Connect Load To X1 & X4
208	-	-	500	85	100	110
220	380	440	550	91	110	120
230	400	460	575	95	115	125
240	416	480	600	99	120	130

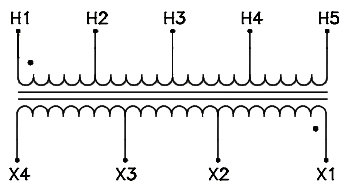

Series 50 Primary Fuse Kit BR-734

Installation Procedure

- Loosen bolts holding transformer to the panel backplate.
- Slide the BR-734 bracket over the transformer.
- Connect the Fuse Holder leads to the transformer terminals with the Jumper Leads furnished.

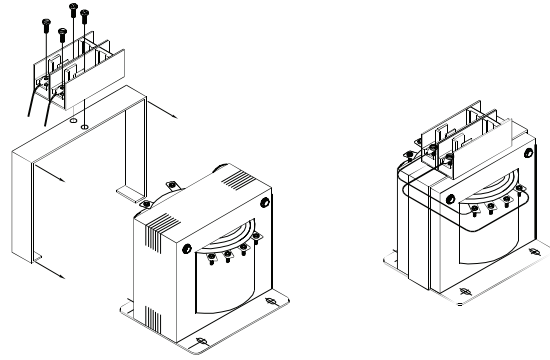

Series 50 Recommended Fuse Type by Manufacturer

Manufacturer	Bussman	Gould	Littlefuse
Primary Fuse Type	FNQ-R	ATQR / ATDR	KLDR / CCRM
Secondary Fuse Type Fuse Holder 265-B	FNM / FNQ (250V) (500V)	TRM / ATQ (250V) (500V)	FLM / FLQ (250V) (500V)
Secondary Fuse Type Fuse Holder GLF 1 1/4	MDQ (250V)	GDL (250V)	3AB (250V)

Note: Fuses sold separately.

Primary Fuse Holder Brackets for 50 Series

Series VA	052	053	054	056	058	059	134
50	BR-734-1	BR-734-1	BR-734-1	BR-734-1			BR-734-1
75	BR-734-1	BR-734-1	BR-734-1	BR-734-1			BR-734-1
100	BR-734-2	BR-734-2	BR-734-2	BR-734-2			BR-734-2
150	BR-734-3	BR-734-3	BR-734-3	BR-734-3		BR-734-6	BR-734-3
200	BR-734-4	BR-734-4	BR-734-4	BR-734-4			BR-734-4
250	BR-734-4	BR-734-4	BR-734-4	BR-734-4	BR-734-4	BR-734-6	BR-734-4
300	BR-734-4	BR-734-4	BR-734-4	BR-734-4			BR-734-4
375	BR-734-4	BR-734-4	BR-734-4	BR-734-4		BR-734-5	BR-734-4
500	BR-734-6	BR-734-6	BR-734-6	BR-734-6	BR-734-6	BR-734-5	BR-734-6
750	BR-734-6	BR-734-6	BR-734-6	BR-734-6	BR-734-5	BR-734-7	BR-734-6
1000	BR-734-6	BR-734-6	BR-734-6	BR-734-6	BR-734-7	BR-734-7	BR-734-6
1500		BR-734-7	BR-734-7	BR-734-7	BR-734-8	BR-734-8	BR-734-7
2000		BR-734-7	BR-734-7	BR-734-7	BR-734-8	BR-734-8	BR-734-7
3000		BR-734-8	BR-734-8	BR-734-8	BR-734-8	BR-734-8	BR-734-8
5000		BR-734-8			BR-734-9		

Series 50 Secondary Fuse Kits

Installation Procedure

- Remove the #10 screw in the transformer terminal to be fused.
- Fasten 265 B Fuse Holder to the transformer terminal with the longer #10 screw provided, as shown in the diagram.
- Connect the load lead to the terminal provided on the 265 B Fuse Holder

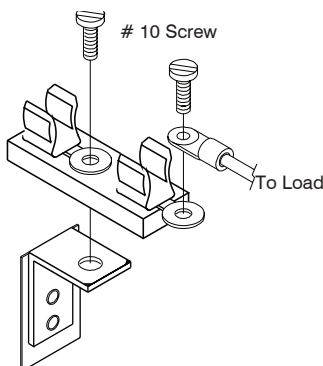

Installation Procedure

- Remove the #6 screw in the transformer terminal to be fused.
- Fasten GLF 1 1/4 Fuse Holder to the transformer terminal with the longer #6 screw provided, as shown in the diagram.
- Connect the load lead to the terminal provided on the GLF 1 1/4 Fuse Holder

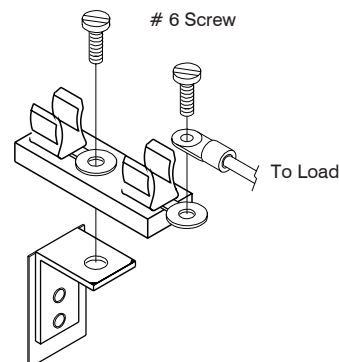

Note: Fuses sold separately.

Selecting and Sizing an Industrial Control Transformer

Selecting The Correct Transformer VA Capacity

Once Selection VA is calculated by one of the below methods, the selection charts on the right can be used.

Calculated Selection Inrush VA should be equal to or greater than the maximum inrush VA from the chart. To assure adequate capacity, a power factor of 40% has been employed in the selection chart.

The use of the 90% or 95% of rated secondary voltage column is recommended for transformer selection. The use of the 85% rated secondary voltage column may not provide adequate voltage output to accommodate existing below normal distribution voltages and voltage dips during equipment and motor startups.

Example:

Sizing Data:

$$\begin{aligned} \text{Sealed VA} &= 270 \text{ VA} \\ \text{Inrush VA} &= 1,728 \text{ VA} \end{aligned}$$

Using the formula in Method 1:

$$\begin{aligned} \text{Selection Inrush VA} &= \sqrt{(\text{VA sealed})^2 + (\text{VA inrush})^2} \\ &= \sqrt{(270)^2 + (1,728)^2} \\ &= 1,749 \text{ VA} \end{aligned}$$

In the above example, at 95% of rated secondary voltage (.4 PF), the correct transformer size is 500 VA.

Using the formula in Method 2:

$$\begin{aligned} &= \text{VA Sealed} + \text{VA Inrush} \\ &= 270 + 1728 \\ &= 1,998 \text{ VA} \end{aligned}$$

In the above example, at 95% of rated secondary voltage (.4 PF), the correct transformer size is 750 VA.

Conversion to kVA:

The formula used to convert single phase VA to kVA is as follows:

$$\text{kVA} = \frac{\text{VA (Volt Amperes)}}{1000}$$

Typical Va Requirements of 3 pole, 60 Hz, 120 volt contractors are listed in the chart below:

Selection Inrush VA Charts

Series IC Inrush VA		Selection Inrush VA at 85%, 90%, and 95% of Rated Secondary Voltage					
VA Rating	Catalog Number	20% Power Factor			40% Power Factor		
		85%	90%	95%	85%	90%	95%
50	IC-0050-xxx	330	270	210	240	200	140
75	IC-0075-xxx	520	430	340	370	310	220
100	IC-0100-xxx	840	690	540	590	480	352
150	IC-0150-xxx	1390	1150	900	1280	1030	722
250	IC-0250-xxx	2850	2300	1850	1980	1650	1060
350	IC-0350-xxx	3980	3200	2580	2900	2400	1680
500	IC-0500-xxx	7400	6130	4800	5200	4340	3200
750	IC-0750-xxx	12000	10400	8100	8800	7400	5100
1000	IC-1000-xxx	19100	15700	11400	13500	11200	7700

Series 50 Inrush VA		Selection Inrush VA at 85%, 90%, and 95% of Rated Secondary Voltage					
VA Rating	Catalog Number	20% Power Factor			40% Power Factor		
		85%	90%	95%	85%	90%	95%
50	50-0050-xxx	270	230	190	250	185	140
75	50-0075-xxx	580	480	350	460	340	250
100	50-0100-xxx	820	660	490	520	410	305
150	50-0150-xxx	1350	1000	820	1250	900	640
200	50-0200-xxx	1920	1380	840	1320	960	690
250	50-0250-xxx	2780	1990	1190	1840	1290	790
300	50-0300-xxx	3600	2680	1630	2470	1800	1070
375	50-0375-xxx	4580	3300	2050	3100	2250	1300
500	50-0500-xxx	6150	4450	2750	4350	3100	1900
750	50-0750-xxx	10200	7300	4300	8450	5500	3700
1000	50-1000-xxx	11800	8400	4600	8900	5900	3950
1500	50-1500-xxx	22400	16300	9200	16500	12900	6900
2000	50-2000-xxx	24600	16800	9800	19600	13300	7200
3000	50-3000-xxx	32500	23600	13900	26500	19600	11700
5000	50-5000-xxx	62000	46000	26800	49800	37200	29500

Series HC Inrush VA		Selection Inrush VA at 85%, 90%, and 95% of Rated Secondary Voltage					
VA Rating	Catalog Number	20% Power Factor			40% Power Factor		
		85%	90%	95%	85%	90%	95%
50	HC-0050-xxx	270	230	190	250	185	140
75	HC-0075-xxx	580	480	350	460	340	250
100	HC-0100-xxx	810	630	440	620	530	350
150	HC-0150-xxx	1350	1050	820	1250	900	640
250	HC-0250-xxx	2040	1610	1170	1940	1420	980
375	HC-0375-xxx	3240	2450	2030	2900	2050	1650
500	HC-0500-xxx	5600	4050	2900	4500	3500	2350
750	HC-0750-xxx	9300	6650	4800	7100	5650	3850
1000	HC-1000-xxx	14500	11000	7900	12600	9700	5800
1500	HC-1500-xxx	24200	18700	13500	19500	14100	9800
2000	HC-2000-xxx	37500	27500	19800	27500	20500	14000

Selecting and Sizing an Industrial Control Transformer

Control Circuit Overcurrent Protection

Current North American Standards specify overcurrent protection on all control circuit transformers. These standards include the US National Electric Code[®], UL 508, and the Canadian Electrical Code. Specified overcurrent protection may be accomplished by one of two options.

Option 1: Provide primary overcurrent protection based on the parameters below.

Option 2: Provide both primary and secondary overcurrent protection. When this option is followed, the

primary overcurrent device should be rated at no more than 250% of rated primary current and the secondary overcurrent device at no more than 125% of rated secondary current.

Option 2 is the preferred method of overcurrent protection, as it minimizes nuisance trips due to startup inrush.

In either method, it is recommended that Class CC, time delay primary fuses be used in order to help prevent nuisance trips.

Recommended Primary Fuse Chart

Primary Voltage																		
VA ↓	115	120	200	208	220	230	240	277	380	400	416	440	460	480	550	575	600	VA ↓
50	1 ¼	1 ¼	¾	⅘	⅘	⅘	⅘	½	⅔	⅔	⅔	⅔	⅔	⅔	¼	¼	⅔	50
75	1 ⅙	1 ⅙	1 ⅛	1	1	⅘	⅘	⅘	½	½	½	½	⅔	⅔	⅔	⅔	⅔	75
100	2 ½	2 ¼	1 ½	1 ⅘	1 ¼	1 ¼	1 ¼	1	¾	¾	⅔	⅔	⅔	⅔	½	½	½	100
150	3 ½	3 ½	2 ¼	2	2	1 ⅙	1 ⅙	1 ⅙	1 ⅛	1 ⅛	1	1	⅔	⅔	⅔	¾	¾	150
200	5	5	3	2 ⅙	2 ½	2 ½	2 ¼	2	1 ½	1 ½	1 ⅙	1 ¼	1 ¼	1 ¼	1	1	⅘	200
250	4	4	3 ½	3 ½	3 ⅔	3 ⅔	3	2 ½	1 ⅛	1 ⅙	1 ⅙	1 ⅙	1 ⅙	1 ½	1 ¼	1 ¼	1 ¼	250
300	5	5	4 ½	4	4	3 ½	3 ½	3 ⅔	2 ¼	2 ¼	2	2	1 ⅙	1 ⅙	1 ⅙	1 ½	1 ½	300
350	5	5	5	5	4 ½	4 ½	4	3 ½	2 ½	2 ½	2 ½	2 ¼	2 ¼	2	1 ⅙	1 ⅙	1 ⅙	350
500	8	8	4 ½	5	4	4	3 ½	5	3 ½	3 ½	3 ½	3 ⅔	3 ⅔	3	2 ½	2 ½	2 ¼	500
750	10	10	7	6	6	6	5	5	5 ⅙	5 ⅙	5	5	4 ½	4 ½	4	3 ½	3 ½	750
1000	15	15	9	8	8	8	7	6	4 ½	4 ½	4	4	3 ½	3 ½	5	5	5	1000
1500	20	15	15	12	12	10	10	9	6 ¼	6 ¼	6	6	6	5	4 ½	4 ½	4	1500
2000	25	20	15	15	15	15	15	12	9	9	8	8	8	7	6	6	6	2000
3000			20	20	20	20	15	15	15	12	12	12	12	10	9	9	9	3000
5000				30	30	30	30	25	20	15	15	15	15	15	15	15	15	5000

Recommended Secondary Fuse Chart

Secondary Voltage												
VA ↓	24	95	100	110	115	120	125	130	220	230	240	VA ↓
50	3 ⅔	⅘	⅘	¾	⅘	⅘			⅔	⅔	⅔	50
75	5	1 ¼	1 ¼	1 ⅛	1	1			½	½	½	75
100	6 ¼	1 ⅙	1 ⅙	1 ½	1 ⅘	1 ¼			¾	⅘	⅘	100
150	10	2 ½	2 ½	2 ¼	2	2			1 ⅛	1	1	150
200	12	3 ½	3 ⅔	3	2 ⅙	2 ½			1 ½	1 ⅙	1 ¼	200
250	15	4	4	3 ½	3 ½	3 ⅔			1 ⅙	1 ⅙	1 ⅙	250
300	20	5	5	4 ½	4	4			2 ¼	2	2	300
350	20	6	5 ⅙	5	5	4 ½			2 ½	2 ½	2 ¼	350
500	30	8	8	7 ½	7	6 ¼			3 ½	3 ½	3 ⅔	500
750	12	12	10	10	10				5 ⅙	5	5	750
1000		15	15	15	15				7	7	7	1000
1500		20	20	20	20				9	8	8	1500
2000		30	30	20	30	20			15	15	12	2000
3000									20	20	20	3000
5000									30	30	30	5000

AP12 - Encapsulated Industrial Control Transformers

Series AP12 Industrial Control Transformers are designed to comply with industrial and automotive specifications that require the control transformer to be mounted in a separate enclosure, remote from the main control panel.

- **50/60 Hertz.**
- **Capacity range from 1 kVA to 10 kVA.**
- Available primary voltages include 208, 240, and 380, 480, 575, 600. Secondary voltage is 120 volts.

Features



- **All copper windings.**
- **NEMA 12 enclosure** and encapsulated core and coil construction.

General Information									
Pri. Volts	240 X 480 230 X 460 220 X 440	208	Dimensions (inches)						Weight (lbs)
Sec. Volts	120 115 110	120	Height A	Width B	Depth C	Depth D	Mounting		
kVA Cap.	Catalog Number	Catalog Number	Height A	Width B	Depth C	Depth D	EE	FF	Weight (lbs)
1.0	AP12-351	AP12-353	10.50	10.00	6.62	8.50	4.00	8.50	50
1.5	AP12-401	AP12-403	12.00	10.81	7.19	9.125	6.00	9.13	68
2.0	AP12-451	AP12-453	14.00	14.00	9.25	12.00	8.00	12.00	97
3.0	AP12-501	AP12-503	14.00	14.00	9.25	12.00	8.00	12.00	120
5.0	AP12-551	AP12-553	14.00	14.38	10.00	12.38	8.00	12.38	149
7.5	AP12-601	AP12-603	15.00	18.00	12.50	16.00	8.00	16.00	198
10.0	AP12-651	AP12-653	15.00	18.00	12.50	16.00	8.00	16.00	225



Dimensions & weights may change. Consult factory for certified drawings.

Series FP12-Encapsulated Industrial Control Transformers

Series FP12 Industrial Control Transformers are similar to the AP12 Series with two important differences. The FP12 Series is 115°C rise (versus 55°C) and they are manufactured with an electrostatic shield between primary and secondary.

Features



- All copper windings.
- NEMA 12 enclosure and encapsulated core and coil construction.
- 50/60 Hz unit weights are approximately 20% higher than those shown.

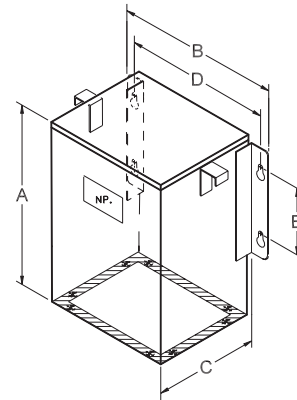

Series FP12
Wall Mount - Encapsulated - NEMA 12

General Information							
Pri. Volts	240 X 480 230 X 460 220 X 440	Dimensions (inches)					Weight (lbs)
Sec. Volts	120 115 110	Height A	Width B	Depth C	Mounting		
kVA Cap.	Catalog Number				D	E	
1.0	FP12-351	10.50	10.00	6.62	8.50	4.00	29
1.5	FP12-401	10.50	10.00	6.62	8.50	4.00	38
2.0	FP12-451	12.00	10.81	7.19	9.13	6.00	45
3.0	FP12-501	14.00	10.81	7.19	9.13	8.00	78
5.0	FP12-551	14.00	14.00	9.25	12.00	8.00	97
7.5	FP12-601	14.00	14.38	10.00	12.38	8.00	151
10.0	FP12-651	14.00	14.38	10.00	12.38	8.00	164

PRIMARY 240 x 480

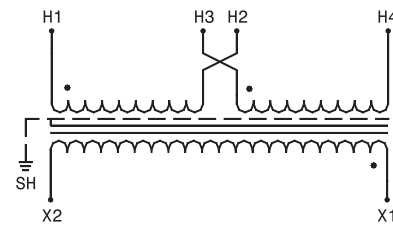

Dimensions & weights may change. Consult factory for certified drawings.



TRANSFORMER DISCONNECTS

For Control Panel Lighting and Auxillary Power

*UL and CUL Listed
TÜV Rheinland Licensed
CE Marked Series*



Transformer Disconnects

Dongan Electric Manufacturing Company is pleased to display its new line of Transformer Lighting Disconnects. The products in this catalog represent the most advanced series of disconnects available in the market today. Most important, these products have the approvals and certifications needed to compete and ship virtually worldwide.

All Dongan Disconnects are UL Listed and Canadian UL Listed. UL File E185781. In addition, all series, except Series TDGK12, ADLK, and ADLK12, are CE Marked and Licensed for the European Union "T" Mark under the EN60204-6/30-06 Safety of Machinery Standard. These Disconnects have undergone extensive testing and certification by TÜV Rheinland and Underwriters Labs.

- NEMA 1/IP23 and NEMA 12/IP54/IP65 enclosure styles.
- Domestic and multitap European voltage combinations.
- Finger - Safe fuses and transformer terminals.
- CE Marked, TÜV Bauart Marked, copper wound transformers.
- European and domestic color coded labels and switches.
- Dongan Transformer Disconnects comply with automotive specifications.



Lighting Disconnect Catalog

Series TDLK

Transformer VA Capacity	Dongan Catalog No.	Pri. Max Amps	Pri. Fuse Size F1 & F2	Sec. Max Amps	Sec. Fuse Size F3*	Max Lighting Amps	Max Duplex Amps	Sec. Fuse Size F4	Approx. Weight Lbs.
250	TDLK-130	.52	1.5	2.08	2.25	2.08	—	—	27
500	TDLK-170	1.04	3.0	4.17	4.5	4.17	—	—	35
750	TDLK-190	1.56	4.5	6.25	6.25	6.25	—	—	45
1000	TDLK-200	2.08	3.25	8.33	2.0	2.00	6.33	7.0	49
1500	TDLK-210	3.13	5.0	12.50	5.0	5.00	7.50	8.0	55
2000	TDLK-230	4.17	6.25	16.67	10.0	9.00	7.50	8.0	69
3000	TDLK-250	6.25	10.0	25.00	10.0	10.00	15.00	15.0	82

Features

- NEMA 1 / IP 23 enclosure.
- Primary Voltage: 480 VAC.
- Secondary Voltage: 120 VAC.
- 50 / 60 Hz.
- 200K AIC RATED
- One side of secondary grounded.
- Transformer is copper wound with electrostatic shield (earth metal screen).
- Finger-safe terminals.
- All overcurrent protection provided: Primary - Class CC Secondary - Supplementary fuses (13/32" x 1 1/2").
- Complies with automotive industry specifications.
- 3 position, pad-lockable cam switch.
- Duplex receptacle provided on 1000 VA through 3000 VA, optional on 250 VA - 750 VA.
- Dedicated physical earth terminal.
- Bonded door ground stud.
- Options: Green, "ON" pilot light available as additional cost option. Other voltage combinations available.

Agency Compliance

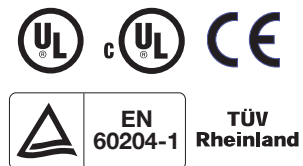

VA	A	B	C	D	E	F
250 - 2000	9.00	14.75	9.13	5.75	13.75	.340
3000	10.75	14.75	9.13	5.75	13.75	.340

Series TDLK Outline Drawings

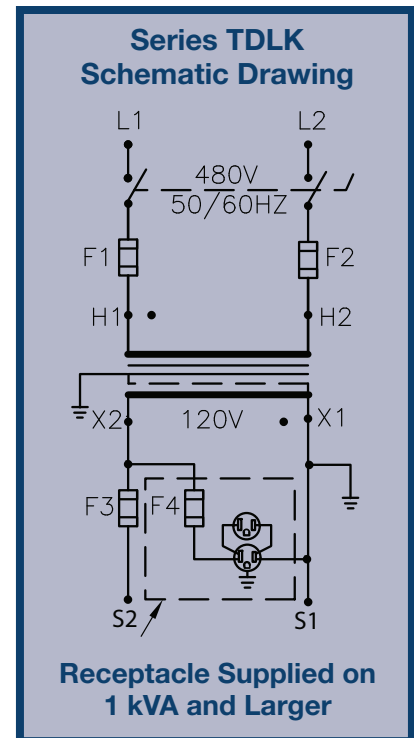
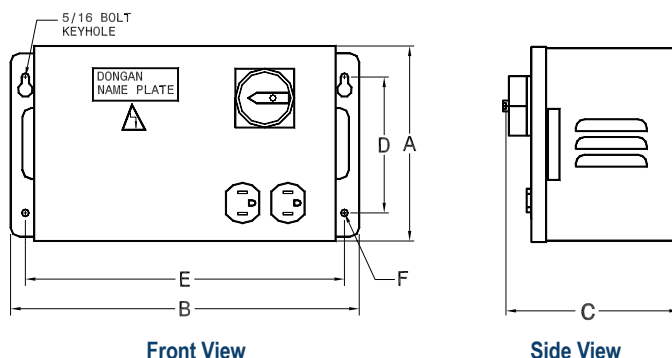

*F3 fuse size will vary if receptacle provided

Series TDLK 12

Transformer VA Capacity	Dongan Catalog No.	Pri. Max Amps	Pri. Fuse Size F1 & F2	Sec. Max Amps	Sec. Fuse Size F3*	Max Lighting Amps	Max Duplex Amps	Sec. Fuse Size F4	Approx. Weight Lbs.
250	TDLK12-130	.52	1.5	2.08	2.25	2.08	—	—	29
500	TDLK12-170	1.04	3.0	4.17	4.5	4.17	—	—	37
750	TDLK12-190	1.56	4.5	6.25	6.25	6.25	—	—	47
1000	TDLK12-200	2.08	3.25	8.33	2.0	2.00	—	—	51
1500	TDLK12-210	3.13	5.0	12.50	5.0	5.00	—	—	57
2000	TDLK12-230	4.17	6.25	16.67	10.0	9.00	—	—	71
3000	TDLK12-250	6.25	10.0	25.00	10.0	10.00	—	—	96

Features

- NEMA 12 / IP 54 enclosure.
 - Primary Voltage: 480 VAC.
 - Secondary Voltage: 120 VAC.
 - 50 / 60 Hz.
 - 200K AIC RATED
 - One side of secondary grounded.
 - Transformer is copper wound with electrostatic shield (earth metal screen).
 - Finger-safe terminals.
 - All overcurrent protection provided
- Primary - Class CC
- Secondary - Supplementary fuses (13/32" x 1 1/2").
- Complies with automotive industry specifications.
 - 3 position, pad-lockable cam switch.
 - Gasketed receptacle available as an added cost option on all sizes.
 - Green "ON" pilot light provided.
 - Dedicated physical earth terminal.
 - Bonded door ground stud.
 - Options: Other voltage combinations available.

Dimensions

VA	A	B	C	D	E	F	G
250 - 2000	12.75	14.00	9.38	9.38	13.00	.340	4.63
3000	15.119	18.00	11.38	11.50	17.00	.340	7.50

Series TDLK 12 Outline Drawings

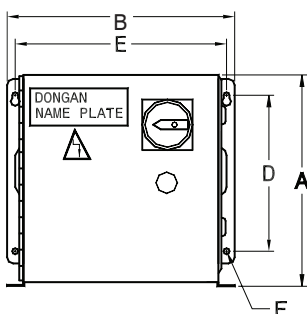

Front View

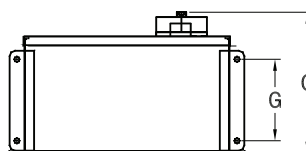

Bottom View

Agency Compliance



Series TDLK 12 Schematic Drawing

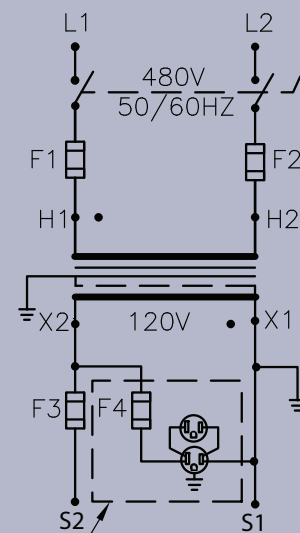

Optional Receptacle Available

*F3 fuse size will vary if receptacle provided

Lighting Disconnect Catalog

Series TDEK

Transformer VA Capacity	Dongan Catalog No.	Pri. Max Amps 380 V*	Sec. Max Amps	Sec. Fuse Size F3*	Max Lighting Amps	Max Duplex Amps	Sec. Fuse Size F4	Approx. Weight Lbs.
250	TDEK-130	.66	2.08	2.25	2.08	—	—	31
500	TDEK-170	1.32	4.17	4.5	4.17	—	—	35
750	TDEK-190	1.97	6.25	6.25	6.25	—	—	45
1000	TDEK-200	2.63	8.33	9.0	8.33	—	—	49
1500	TDEK-210	3.95	12.50	15.0	12.50	—	—	55
2000	TDEK-230	5.26	16.67	20.0	16.67	—	—	69
3000	TDEK-250	7.90	25.00	25.0	25.00	—	—	86

* Primary max amps for other voltages may be obtained by dividing VA by line voltage

Features

- **NEMA 3R/IP23 Enclosure.**
- **Primary Voltage: 380/400/416/440/460/480/575 VAC.**
- **Secondary Voltage: 110/115/120 VAC.**
- **50 / 60 Hz.**
- **200K AIC RATED**
- One side of secondary grounded.
- Transformer is copper wound with electrostatic shield (earth metal screen).
- Finger-safe terminals.
- All overcurrent protection provided: Primary - Class CC
- Secondary - Supplementary fuses (13/32" x 1 1/2").
- Complies with automotive industry specifications.
- 3 position, pad-lockable cam switch.
- Gasketed receptacle available as an added cost option on all sizes.
- Green "ON" pilot light provided.
- Dedicated physical earth terminal.
- Bonded door ground stud.
- Options: Other voltage combinations available.

Dimensions

VA	A	B	C	D	E	F
250 - 2000	9.00	14.75	9.13	5.75	13.75	.340
3000	10.75	14.75	9.13	5.75	13.75	.340

Series TDEK Outline Drawings

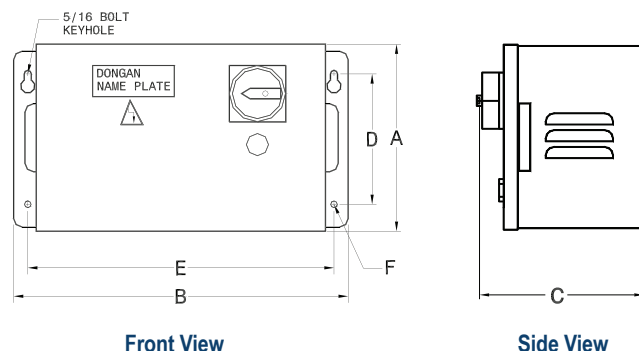

Agency Compliance

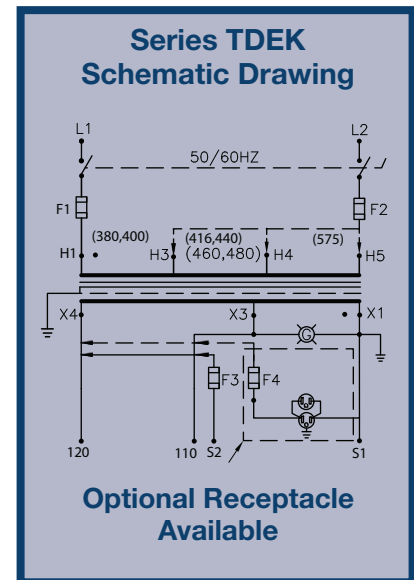

Optional Receptacle Available

*F3 fuse size will vary if receptacle provided

Series TDEK 12

Transformer VA Capacity	Dongan Catalog No.	Pri. Max Amps 380 V*	Sec. Max Amps	Sec. Fuse Size F3*	Max Lighting Amps	Max Receptacle Amps	Sec. Fuse Size F4	Approx. Weight Lbs.
250	TDEK12-130	0.66	2.08	2.25	2.08	—	—	33
500	TDEK12-170	1.32	4.17	4.5	4.17	—	—	37
750	TDEK12-190	1.97	6.25	6.25	6.25	—	—	47
1000	TDEK12-200	2.63	8.33	9.0	8.33	—	—	51
1500	TDEK12-210	3.95	12.50	15.0	12.50	—	—	57
2000	TDEK12-230	5.26	16.67	20.0	16.67	—	—	71
3000	TDEK12-250	7.90	25.00	25.0	25.00	—	—	100

* Primary max amps for other voltages may be obtained by dividing VA by line voltage

Features

- **NEMA 12/IP65 Enclosure.**
 - **Primary Voltage: 380/400/416/440/460/480/575 VAC.**
 - **Secondary Voltage: 110/115/120 VAC.**
 - **50 / 60 Hz.**
 - **200K AIC RATED**
 - Complies with automotive
 - Both sides of secondary isolated from ground.
 - Transformer is copper wound with electrostatic shield (earth metal screen).
 - Finger-safe terminals.
 - Primary overcurrent protection provided:
- Primary - Class CC
 - Secondary fuse holders only for 13/32" x 1 1/2" fuses.
 - Complies with automotive industry specifications.
 - 3 position, pad-lockable cam switch.
 - Green "ON" pilot light provided.
 - Dedicated physical earth terminal.
 - Bonded door ground stud.
 - Options: Other voltage combinations available.

Dimensions

VA	A	B	C	D	E	F	G
250 - 2000	12.75	14.00	9.38	9.38	13.00	.340	4.63
3000	15.19	18.00	11.38	11.50	17.00	.410	7.50

Series TDEK 12 Outline Drawings

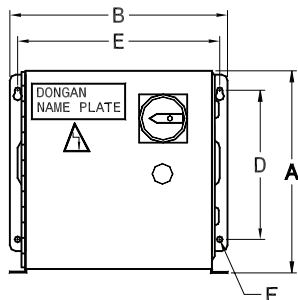

Front View

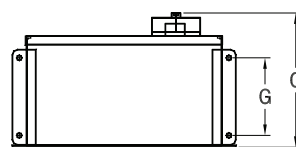

Side View

Agency Compliance

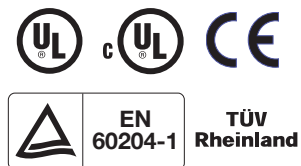

Series TDEK 12 Schematic Drawing

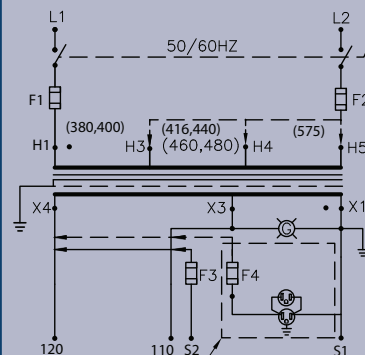

Optional Receptacle Available

*F3 fuse size will vary if receptacle provided

Transformer Lighting Disconnect

Series ADLK

Transformer VA Capacity	Dongan Catalog No.	Pri. Max Amps	Pri. Fuse Size F1 & F2	Sec. Max Amps	Sec. Fuse Size F3*	Max Lighting Amps	Max Duplex Amps	Sec. Fuse Size F4	Approx. Weight Lbs.
250	ADLK-130	.52	1.5	2.08	2.25	2.08	—	—	27
500	ADLK-170	1.04	3.0	4.17	4.5	4.17	—	—	31
750	ADLK-190	1.56	4.5	6.25	6.25	6.25	—	—	35
1000	ADLK-200	2.08	3.2	8.33	2.0	2.08	6.33	7.0	44
1500	ADLK-210	3.13	5.0	12.50	5.0	5.00	7.50	8.0	49
2000	ADLK-230	4.17	6.25	16.67	10.0	9.00	7.50	8.0	56
3000	ADLK-250	6.25	10.0	25.00	10.0	10.00	15.00	15.0	69

Features

- **NEMA 1 / IP 23 enclosure**
- **Primary Voltage: 480 VAC**
- **Secondary Voltage: 120 VAC.**
- **60 Hz**
- **200K AIC RATED.**
- One side of secondary grounded.
- Transformer is copper wound with electrostatic shield (earth metal screen).
- Finger-safe terminals.
- All overcurrent protection provided:
 - Primary - Class CC
 - Secondary - Supplementary fuses (13/32" x 1 1/2").
- Complies with automotive industry specifications.
- 3 position, pad-lockable cam switch.
- Duplex receptacle provided on 1000 VA through 3000 VA, optional on 250 VA - 750 VA.
- Dedicated physical earth terminal.
- Bonded door ground stud.
- Options: Green or red "ON" pilot light available as additional cost option. Other voltage combinations available.

Dimensions

VA	A	B	C	D	E	F
250 - 3000	9.00	14.75	9.13	5.75	13.75	.340

Series ADLK Outline Drawings

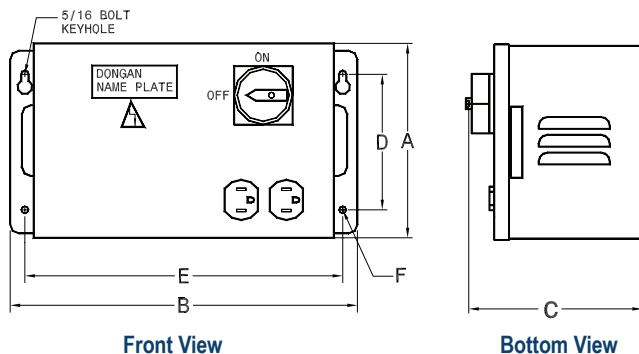

Agency Compliance



Series ADLK Schematic Drawing

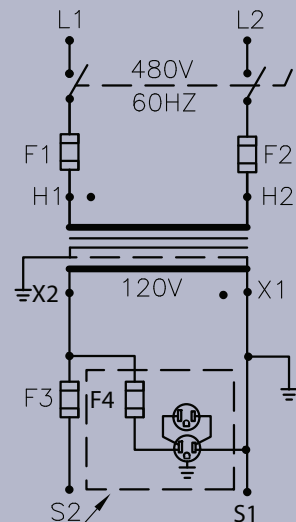

Optional Receptacle Available

*F3 fuse size will vary if receptacle provided

Transformer Lighting Disconnect

Series ADLK 12

Transformer VA Capacity	Dongan Catalog No.	Pri. Max Amps	Pri. Fuse Size F1 & F2	Sec. Max Amps	Sec. Fuse Size F3*	Max Lighting Amps	Max Duplex Amps	Sec. Fuse Size F4	Approx. Weight Lbs.
250	ADLK12-130	.52	1.5	2.08	2.25	2.08	—	—	27
500	ADLK12-170	1.04	3.0	4.17	4.5	4.17	—	—	31
750	ADLK12-190	1.56	4.5	6.25	6.25	6.25	—	—	35
1000	ADLK1-200	2.08	3.2	8.33	2.0	2.08	6.33	7.0	44
1500	ADLK12-210	3.13	5.0	12.50	5.0	5.00	7.50	8.0	49
2000	ADLK12-230	4.17	6.25	16.67	10.0	9.00	7.50	8.0	56
3000	ADLK12-250	6.25	10.0	25.00	10.0	10.00	15.00	15.0	69

Features

- **NEMA 12/IP65 enclosure**
- **Primary Voltage: 480 VAC**
- **Secondary Voltage: 120 VAC.**
- **60 Hz**
- **200K AIC RATED.**
- One side of secondary grounded.
- Transformer is copper wound with electrostatic shield (earth metal screen).
- Finger-safe terminals.
- All overcurrent protection provided:
 - Primary - Class CC
 - Secondary - Supplementary fuses (13/32" x 1 1/2").
- Complies with automotive industry specifications.
- 3 position, pad-lockable cam switch.
- Dedicated physical earth terminal.
- Bonded door ground stud.
- Options: Green or red "ON" pilot light available as additional cost option. Other voltage combinations available.

Dimensions

VA	A	B	C	D	E	F
250 - 3000	9.00	14.75	9.13	5.75	13.75	.340

Series ADLK 12 Outline Drawings

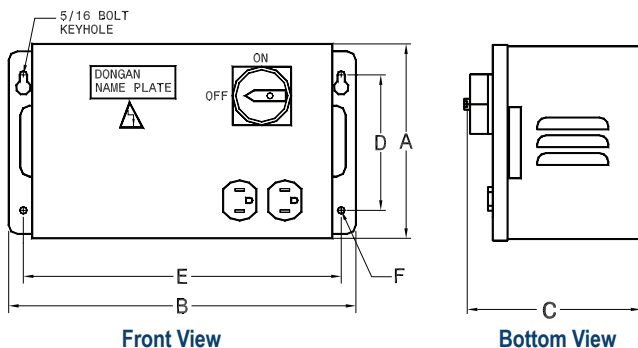

Agency Compliance



Series ADLK 12 Schematic Drawing

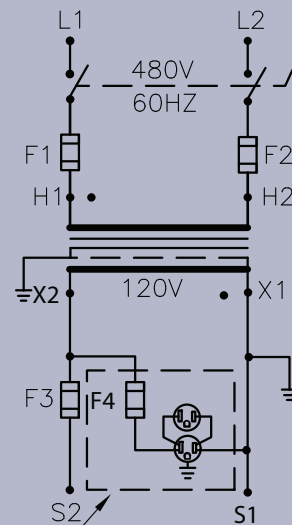

Optional Receptacle Available

*F3 fuse size will vary if receptacle provided

Large Capacity Transformer Lighting Disconnect

Series TDGK 12

Transformer VA Capacity	Dongan Catalog No.	Pri. Max Amps	Pri. Fuse Size F1 & F2	Sec. Max Amps	Sec. Fuse Size F3*	Sec. Fuse Size with Receptacle F3*	Sec. Fuse Size with Receptacle F4	Approx. Weight Lbs.
5000	TDGK12-300	10.41	15.0	41.66	45.0	35.0	6.0	125
7500	TDGK12-330	15.62	25.0	60.00	60.0	50.0	10.0	150

Features

- NEMA 12 / IP 54 enclosure.
- Primary Voltage: 480 VAC.
- Secondary Voltage: 120 VAC.
- 60 Hz.
- 200K AIC RATED.
- Large capacity - 5000 VA and 7500 VA.
- One side of secondary grounded.
- Transformer is copper wound with electrostatic shield (earth metal screen).
- Finger-safe terminals.
- 3 position, pad-lockable cam switch.
- Green "ON" pilot light provided.
- All overcurrent protection provided:
 - Primary - Class CC
 - Secondary - Supplementary fuses (1 1/16" x 2 3/8").
- Gasketed duplex receptacle available as additional cost option.
- Dedicated physical earth terminal.
- Bonded door ground stud.
- Options: Other voltage combinations available.

Dimensions

VA	A	B	C	D	E	F	G
5000 - 7500	15.19	18.00	11.50	11.50	17.00	.410	7.50

Series TDGK 12 Outline Drawings

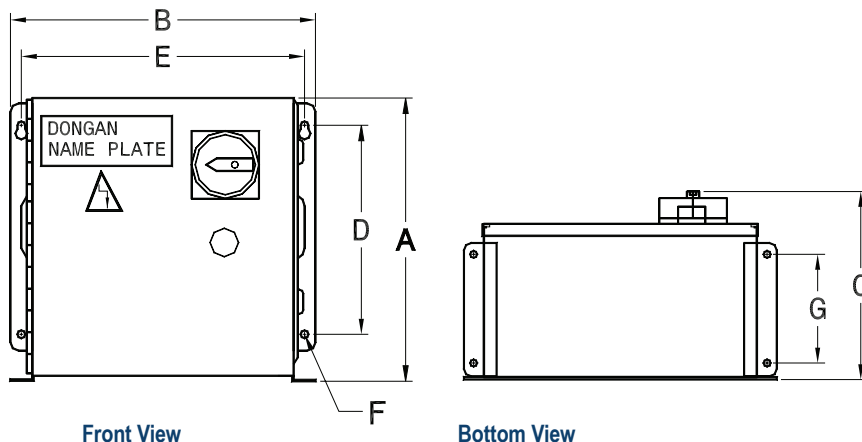

Agency Compliance



Series TDGK 12 Schematic Drawing

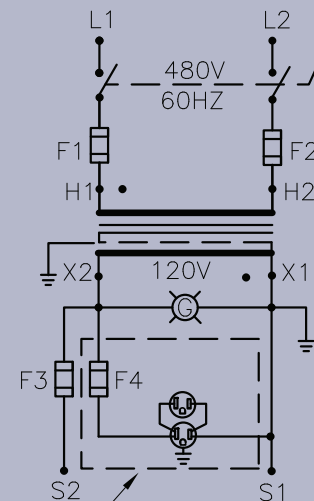

Optional Receptacle Available

*F3 fuse size will vary if receptacle provided

Compact Transformer - Lighting Disconnects

Series TMAK, TMBK and TMCK

The Dongan Compact Series Transformer Lighting Disconnects are designed to minimize backplate footprints to save valuable control panel space. Compact Series are available in three standard circuits with four VA sizes for each circuit configuration. Epoxy encapsulated, the Compact Series offers cool operating temperatures, a green “ON” pilot light, and circuit options that include a duplex receptacle as well as grounded and ungrounded secondaries.

Transformer VA Capacity	Dongan Catalog No.	Circuit Style	Pri. Max Amps	Pri. Fuse Size F1 & F2	Sec. Max Amps	Sec. Fuse Size F3*	Max Lighting Amps	Max Duplex Amps	Sec. Fuse Size F4	Approx. Weight Lbs.
250	TMAK-130	A	.52	1.5	2.08	††	†	†	††	15
500	TMAK-170	A	1.04	3.0	4.17	††	†	†	††	20
750	TMAK-190	A	1.56	4.5	6.25	††	†	†	††	25
1000	TMAK-200	A	2.08	6.0	8.33	††	†	†	††	30
250	TMBK-130	B	.52	1.5	2.08	2.25	2.08	—	—	15
500	TMBK-170	B	1.04	3.0	4.17	4.5	4.17	—	—	20
750	TMBK-190	B	1.56	4.5	6.25	6.25	6.25	—	—	25
1000	TMBK-200	B	2.08	6.0	8.33	9.0	8.33	—	—	30
250	TMCK-130	C	.52	1.5	2.08	2.25	2.08	—	2.25	15
500	TMCK-170	C	1.04	3.0	4.17	4.5	4.17	—	4.5	20
750	TMCK-190	C	1.56	4.5	6.25	6.25	6.25	—	6.25	25
1000	TMCK-200	C	2.08	6.0	8.33	9.0	8.33	—	9.0	30

† Total of lighting amps and duplex amps must not exceed secondary amp rating.
 †† Fuse sizes of F3 and F4 are based on the load and maximum secondary amps.

* F3 fuse size will vary if receptacle provided

Features

- NEMA 1 / IP 23 enclosure.
- Primary Voltage: 480 VAC.
- Secondary Voltage: 120 VAC.
- 60 Hz.
- 200K AIC RATED
- Compact, panel space-saving design.
- Choice of three circuit designs.
- Transformer is copper wound with electrostatic shield (earth metal screen).
- Finger-safe terminals.
- 3 position, pad-lockable cam switch.
- Green “ON” pilot light provided.
- Primary overcurrent protection provided:
 Primary - Class CC
- Dedicated physical earth terminal.
- Bonded door ground stud.
- Options: Other voltage combinations available.
- Complies with automotive industry specifications.
- TOAK, TOBK & TOCK open style available.



Compact Transformer - Lighting Disconnects

Circuit Configurations

Agency Compliance



Series TMAK
Schematic Drawing

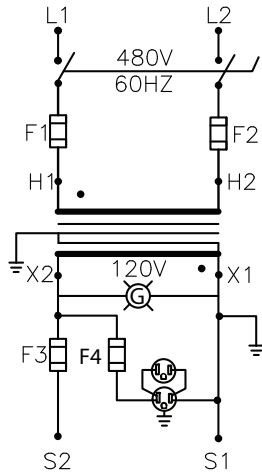

Agency Compliance



Series TMBK
Schematic Drawing

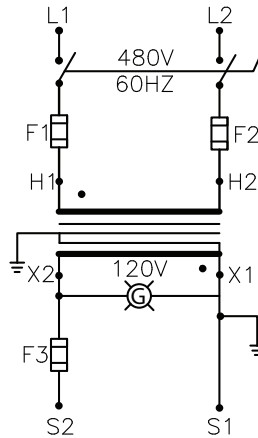

Agency Compliance



Series TMCK
Schematic Drawing

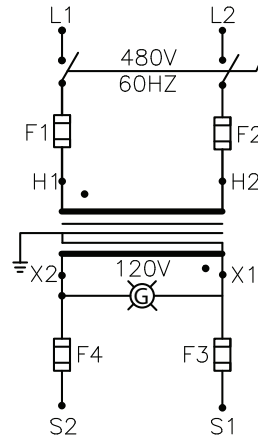

Dimensions

VA	A	B	C	D	E	F
250 - 1000	7.50	8.75	10.38	6.88	6.0	.250

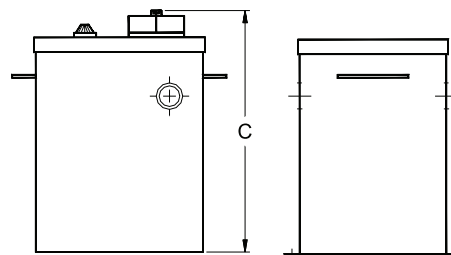
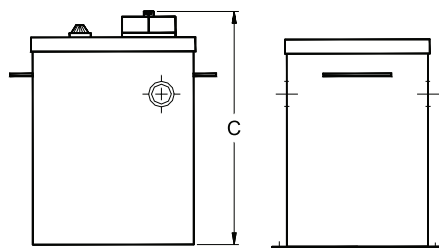
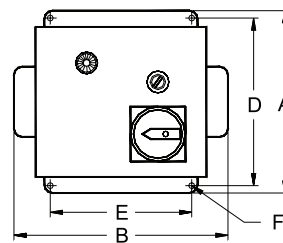
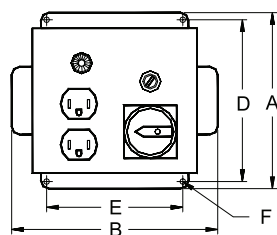

Series TMAK
Dimensions

Series TMBK & TMCK
Dimensions

Transformer Terms and Definitions

Reverse Connecting Transformers:

Because transformers are based on the ratio of turns between two windings insulated from each other, it would appear that there should be no problem with using what is designated as the primary for the secondary, and vice versa. For instance, someone needing 480 volts from a 120 volt source should be able to use a transformer designed to transform 480 volts to 120 volts wired backwards.

Most transformers sized 1 kVA and above in this catalog can be used in this manner. However, because of certain design limitations inherent in transformers below 1 kVA, these should not be reverse connected without checking with our engineering staff. Small transformers are usually made with a turns compensation to help offset losses. This compensation will result in an output voltage that is significantly lower than the primary voltage shown on the nameplate if the transformer is reverse connected.

Motor Drive Isolation Transformers:

Transformers for Motor Drive Isolation are specifically designed with additional cooling; the windings are designed with additional support so as to better withstand the constant physical stress on them caused by the heavy loads that occur each time the thyristors in the drive fire. They are also shielded to keep the electrical noise created by the drive unit from radiating back through the transformer into the building's power system.

Grounding:

The National Electric Code®, Articles 250 and 450, NEMA ST 20 and local electrical codes mandate methods and practices for providing adequate and appropriate conductor grounds and enclosure bonds.

Grounding is important because it increases the safety of the installation by permitting a path to ground should the transformer's coil make contact with the transformer core or enclosure and for passing accumulated static charge buildup to ground. Proper grounding in transformer installations is essential in increasing the safety of personnel.

Grounding conductors are sized in accordance with the above cited codes. All ground connections must be free of paint and nonconductive materials including rust, dust and corrosion. In addition, connections must be tight at all points in order to maintain adequate bonds throughout.

Installing to minimize "Hum":

All energized transformers hum due to the alternating magnetic field in the transformer's core. Dongan® transformers are designed to minimize this noise. While transformer noise is not avoidable, certain installation techniques will reduce noise complaints.

A transformer should be installed where it will be the least objectionable. This is generally away from quiet areas of a facility. If the ambient sound levels are required to be quieter than the transformer's rated sound output, move the transformer to a remote or noisier area. In addition, transformers should be installed where sound will not reflect from close surfaces such as nearby walls, ceilings or floors.

Installations should not be chosen that will resonate sound. This might occur on thin walls or structures on which the transformer is mounted or from rigid conduit connections.

The best installations are those that most effectively isolate the transformer from its surrounding support structures and connections.

Dongan® transformers comply with ANSI

and NEMA standards for sound requirements.

These standards establish maximum sound levels for various transformer kVA ratings as listed in the chart.

Transformer kVA Range	Average Sound Level (Decibels)
0 - 9	40
10 - 50	45
51 - 150	50
151 - 300	55
301 - 500	60

kVA / Ampacity Ratings for Single Phase AC Voltages													
kVA	12V	16V	24V	32V	48V	120V	208V	240V	277V	380V	415V	480V	600V
.050	4.2	3.1	2.1	1.6	1.0	.42	.24	.21	.18	.13	.12	.10	.08
.100	8.3	6.2	4.2	3.3	2.0	.83	.48	.42	.36	.26	.24	.21	.17
.150	12.5	9.4	6.3	4.6	3.1	1.3	.72	.63	.54	.39	.36	.31	.25
.250	20.8	15.6	10.4	7.8	5.2	2.1	1.2	1.0	.90	.66	.60	.52	.42
.500	41.7	31.2	20.8	15.6	10.4	4.2	2.4	2.1	1.8	1.3	1.2	1.0	.83
.750	62	47	31.3	23.4	16.6	6.3	3.6	3.1	2.7	2.0	1.8	1.6	1.3
1	83	62	41.7	31.2	20.8	8.3	4.8	4.2	3.6	2.6	2.4	2.1	1.7
1.5	125	94	62	47	31.2	12.5	7.2	6.3	5.4	3.9	3.6	3.1	2.5
2	166	125	83	62.5	41.6	16.7	9.6	8.3	7.2	5.3	4.8	4.2	3.3
3	250	188	125	94	62	25.0	14.4	12.5	10.8	7.9	7.2	6.3	5.0
5	416	312	208	156	104	41.7	24.0	20.8	18.1	13.2	12.0	10.4	8.3
7.5						62	36.1	31.3	27.1	19.7	18.1	15.6	12.5
10						83	48.1	41.7	36.1	26.3	24.1	20.8	16.7
15						125	72	62	54	39.5	36.1	31.3	25.0
25						208	120	104	90	65	60	52	41.7
37.5						312	180	156	135	98	90	78	62
50						416	240	208	180	131	120	104	83
75						625	360	312	270	197	180	156	125
100						833	480	416	361	263	240	208	166

Note:

Increase transformer kVA by 20% when motors are started more than once per hour.

Multiply motor ampacity by 1.1 and 1.25 respectively for 90% and 80% power factors.

Sizing Transformers

How to Determine Transformer kVA Ratings

Transformer Load expressed in amperes:

Select the appropriate kVA size from the selection charts listed on this page or by using the single phase or three phase sizing formula listed below. Be sure to select a transformer kVA rating equal to or greater than the anticipated connected load.

$$\text{Single Phase kVA} = \frac{\text{Load Voltage} \times \text{Load Amps}}{1000} \quad \text{kVA} = \frac{\text{Volt Amperes}}{100}$$

$$\text{Three Phase kVA} = \frac{\text{Load Voltage} \times \text{Load Amps} \times 1.73}{1000} \quad \text{VA} = \text{kVA} \times 1000$$

Note:

High Ambient Temperature Applications: Derate the transformer nameplate kVA 8% for each 10°C above 40°C up to 60°C. Consult factory for ambients above 60°C.

High Altitude Applications: To allow for reduced cooling at higher elevations, derate the transformer nameplate kVA by .3% for each 330 feet over 3300 feet above sea level.

kVA / Ampacity Ratings for Three Phase AC Voltages								
kVA	200V	208V	240V	380V	415V	480V	575V	600V
3	8.6	8.3	7.2	4.5	4.1	3.6	3.0	2.8
6	17.3	16.6	14.4	9.1	8.3	7.2	6.0	5.7
9	26.0	25.0	21.6	13.6	12.5	10.8	9.0	8.6
15	43.3	41.6	36.1	22.8	20.8	18.0	15.0	14.4
25	72	69	60	38.0	34.8	30.1	25.1	24.0
30	86	83	72	45.6	41.7	36.1	30.1	28.9
45	130	125	108	68	62	54	45.2	43.3
75	216	208	180	114	104	90	75	72
112.5	325	312	270	171	156	135	113	108
150	433	416	361	228	208	180	150	144

Full Load Amperes - Single Phase AC Motor Voltages						
HP	115V	200V	208V	230V	Minimum Transformer kVA	Std. Dongan® Size
1/6	4.4	2.5	2.4	2.2	.53	.750
1/4	5.8	3.3	3.2	2.9	.70	.750
1/3	7.2	4.1	4.0	3.6	.87	1
1/2	9.8	5.6	5.4	4.9	1.18	1.5
3/4	13.8	7.9	7.6	6.9	1.68	2
1	16	9.2	8.8	8	1.92	2
1 1/2	20	11.5	11	10	2.40	3
2	24	13.8	13.2	12	2.88	3
3	34	19.6	18.7	17	4.10	5
5	56	32.2	30.8	28	6.72	7.5
7 1/2	80	46	44	40	9.60	10
10	100	57.5	55	50	12.0	15

Full Load Amperes - Three Phase AC Motor Voltages						
HP	208V	230V	460V	575V	Min. Transformer kVA	Std. Dongan® Size
1/2	2.4	2.2	1.1	.9	0.9	3
3/4	3.5	3.2	1.6	1.3	1.2	3
1	4.6	4.2	2.1	1.7	1.5	3
1 1/2	6.6	6.0	3.0	2.4	2.1	3
2	7.5	6.8	3.4	2.7	2.7	3
3	10.6	9.6	4.8	3.9	3.8	6
5	16.7	15.2	7.6	6.1	6.3	9
7 1/2	24.2	22	11	9	9.2	15
10	30.8	28	14	11	11.2	15
15	46.2	42	21	17	16.6	25
20	59.4	54	27	22	21.6	25
25	74.8	68	34	27	26.6	30
30	88	8	40	32	32.4	45
40	114	104	52	41	43.2	45
50	143	130	65	52	52	75
60	169	154	77	62	64	75
75	211	192	96	77	80	112.5
100	273	248	124	99	103	112.5
125	343	312	156	125	130	150
150	396	360	180	144	15	150

The Dongan® Electric Instrument Company was established in Albany, New York, as a New York corporation. Initial products included the manufacture of ammeters and voltmeters for the growing automotive business

Dongan® was acquired in 1909 by Mr. Lyle J. Hicks, who had been working as an electrical engineer for General Electric Company in Schenectady, New York. The Company was moved to Detroit, Michigan in 1911 and renamed Dongan® Electric Manufacturing Company, establishing the Company as a Michigan corporation. The Corporate name was taken from Governor Dongan, the first appointed Colonial governor of the Territory of New York in 1682.

The Company quickly began the manufacture of low voltage bell ringing transformers. Some of the first Underwriters' Laboratories approvals are dated February 10, 1911 covering door bell transformers equipped with secondary output of 6, 12, and 18 volts. These early products had the additional approvals of the National Board of Fire underwriters. Continued success in the transformer industry led to decisions making transformers the principal product to which the company was to compete.

The Roaring '20's ushered in popular and certainly more affordable console radios. Originally powered by dry-cell "B" batteries, radios were rapidly converted to power tubes. During this time, Dongan® introduced radio voltmeters, amplifier transformers, filament heating transformers and chokes compatible with Raytheon, R.C.A. and Cunningham radio tubes. These products were assembled into a package that eliminated B batteries from radios and allowed the radio to be operated from wall outlets.

This decade also saw the emergence of electric toys

and trains. The demand for transformers to operate trains manufactured by Lionel, American Flyer, Ives and Bing was met with a series of various sized transformer products from Dongan®.

The popularity of neon signs in the '30's created a mark for "luminous tube", or neon transformers. Dongan® achieved one of the first Underwriters' Laboratories approval for neon transformers and powered signs across the country including the famed Radio City Music Hall.

Technology moved to provide other opportunities in the '30's as well. Coal fired furnaces began to give way to oil heat. Dongan® responded with a complete line of replacement oil burner ignition transformers. The demand for these products became so substantial that a n 8,000 square foot facility was built in Pioneer, Ohio to help meet production requirements. The facility was formed as a wholly owned subsidiary under the name of Pioneer Transformer Company by Charles E. "Bud" Hicks, son of Lyle Hicks.

General purpose power distribution transformers, industrial control and other more specialized designs were gradually added to the product line during the '40's, and '50's. Wartime production included both existing product lines and Department of Defense related parts for gun sights.

More recent products include reactors, Class 2 Transformers, K - Rated transformers, transformer lighting disconnects ad related products.

Today, Dongan® combines our 108 year history of speciality transformer manufacturing expertise with a complete catalog of stock transformers for the distributor, OEM and MRO markets. We are proud of our heritage and look forward to serving our customer base into the new millennium.

Alphanumeric Page Reference

265 B	69	50-0200-134	65-67	63-0407SH	31	63-2914SH	31
33-050-17	17	50-0250-052	65-67	63-0503SH	31	63-2920SH	31
33-050-18	17	50-0250-053	65-67	63-0506SH	31	63-2927SH	31
33-050-26	17	50-0250-054	65-67	63-0507SH	31	63-2934SH	31
33-050-82	17	50-0250-056	65-67	63-0703SH	31	63-2940SH	31
33-050-H	17	50-0250-058	65-67	63-0706SH	31	63-2951SH	31
33-050-HLK	17	50-0250-059	65-67	63-0707SH	31	63-2963SH	31
33-050-K	17	50-0250-134	65-67	63-0803SH	31	63-2975SH	31
33-050-PM	17	50-0300-052	65-67	63-0806SH	31	63-2993SH	31
33-100-17	17	50-0300-053	65-67	63-0807SH	31	63-30-3117SH	26
33-100-18	17	50-0300-054	65-67	63-0903SH	31	63-30-407SH	26
33-100-26	17	50-0300-056	65-67	63-0906SH	31	63-30-834SH	25
33-100-82	17	50-0300-134	65-67	63-0907SH	31	63-45-3117SH	26
33-100-H	17	50-0375-052	65-67	63-112-3117SH	26	63-45-407SH	26
33-100-HLK	17	50-0375-053	65-67	63-112-407SH	26	63-45-834SH	26
33-100-K	17	50-0375-054	65-67	63-112-834SH	25	63-60112SH	24
33-100-PM	17	50-0375-056	65-67	63-150-3117SH	26	73-60150SH	24
33-150-PM	17	50-0375-059	65-67	63-150-407SH	26	73-6015SH	24
33-250-PM	17	50-0375-134	65-67	63-150-834SH	25	73-6030SH	24
34-280-ODY	34	50-0500-052	65-67	63-15-3117SH	26	73-6045SH	24
34-560-ODY	34	50-0500-053	65-67	63-15-407SH	26	73-6075SH	24
34-840-ODY	34	50-0500-054	65-67	63-15-834SH	26	73-610112SH	24
35-1005	5	50-0500-056	65-67	63-21118SH	31	73-610150SH	24
35-1010	5	50-0500-058	65-67	63-2111SH	31	73-61015SH	24
35-1015	5	50-0500-059	65-67	63-21145SH	31	73-61030SH	24
35-1020	5	50-0500-134	65-67	63-2114SH	31	73-61045SH	24
35-1025	5	50-0750-052	65-67	63-2120SH	31	73-61075SH	23
35-1030	5	50-0750-053	65-67	63-2127SH	31	73-62112SH	23
35-2010	5	50-0750-054	65-67	63-2134SH	31	73-62150SH	23
35-2015	5	50-0750-056	65-67	63-2140SH	31	73-6215SH	23
35-2020	5	50-0750-058	65-67	63-2151SH	31	73-6230SH	23
35-2025	5	50-0750-059	65-67	63-2163SH	31	73-6245SH	23
35-2030	5	50-0750-134	65-67	63-2175SH	31	73-6275SH	23
35-3010	6	50-1000-052	65-67	63-2193SH	31	73-63112SH	23
35-3015	6	50-1000-053	65-67	63-24118SH	31	73-63150SH	23
35-3020	6	50-1000-054	65-67	63-2411SH	31	73-6315SH	23
35-3025	6	50-1000-056	65-67	63-24145SH	31	73-6330SH	23
35-3030	6	50-1000-058	65-67	63-2414SH	31	73-6345SH	23
35-4010	6	50-1000-059	65-67	63-2420SH	31	73-6375SH	24
35-4015	6	50-1000-134	65-67	63-2427SH	31	73-6615SH	24
35-4020	6	50-1500-053	65-67	63-2434SH	31	73-6630SH	24
35-4025	6	50-1500-054	65-67	63-2440SH	31	73-6645SH	24
35-4030	6	50-1500-056	65-67	63-2451SH	31	63-75-3117SH	26
35-5010	7	50-1500-058	65-67	63-2463SH	31	63-75-407SH	26
35-5015	7	50-1500-059	65-67	63-2475SH	31	63-75-834SH	25
35-5020	7	50-1500-134	65-67	63-2493SH	31	76-0003SH	24
35-5025	7	50-2000-053	65-67	63-25118SH	31	76-0006SH	24
35-6010	7	50-2000-054	65-67	63-2511SH	31	76-0009SH	24
35-6015	7	50-2000-056	65-67	63-25145SH	31	76-01003SH	24
35-6020	7	50-2000-058	65-67	63-2514SH	31	76-01006SH	24
35-6025	7	50-2000-059	65-67	63-2520SH	31	76-01009SH	31
35-6030	7	50-2000-134	65-67	63-2527SH	31	76-0203SH	23
35-LM010	48	50-3000-053	65-67	63-2534SH	31	76-0206SH	23
35-LM015	48	50-3000-054	65-67	63-2540SH	31	76-0209SH	23
35-M005	48	50-3000-056	65-67	63-2551SH	31	76-0303SH	23
35-M010	48	50-3000-058	65-67	63-2563SH	31	76-0306SH	23
35-M015	48	50-3000-059	65-67	63-2575SH	31	76-0309SH	24
35-Y005	48	50-3000-134	65-67	63-2593SH	31	76-0603SH	24
35-Y010	48	50-5000-053	65-67	63-27118SH	31	76-0606SH	24
35-Y015	48	50-5000-058	65-67	63-2711SH	31	76-0609SH	27
50-0050-052	65-67	61-1460SH	5	63-27145SH	31	76-2215SH	27
50-0050-053	65-67	61-1465SH	5	63-2714SH	31	76-2225SH	27
50-0050-054	65-67	41-1470SH	5	63-2720SH	31	76-2230SH	27
50-0050-056	65-67	41-1475SH	5	63-2727SH	31	76-2245SH	27
50-0050-134	65-67	41-1680SH	5	63-2734SH	31	76-2275SH	27
50-0075-052	65-67	41-1685SH	5	63-2740SH	31	76-2315SH	27
50-0075-053	65-67	41-1690SH	5	63-2751SH	31	76-2325SH	27
50-0075-054	65-67	41-1695SH	5	63-2763SH	31	76-2330SH	27
50-0075-056	65-67	41-3470SH	6	63-2775SH	31	76-2345SH	27
50-0075-134	65-67	41-3475SH	6	63-2793SH	31	76-2375SH	27
50-0100-052	65-67	41-4470SH	6	63-28118SH	31	76-3-3117SH	26
50-0100-053	65-67	41-4475SH	6	63-2811SH	31	76-3-407SH	26
50-0100-054	65-67	41-5470SH	7	63-28145SH	31	76-3-834SH	25
50-0100-056	65-67	41-5475SH	7	63-2814SH	31	76-6-3117SH	26
50-0100-134	65-67	41-5480SH	7	63-2820SH	31	76-6-407SH	26
50-0150-052	65-67	41-5485SH	7	63-2827SH	31	76-6-834SH	26
50-0150-053	65-67	41-5490SH	7	63-2834SH	31	76-9-3117SH	26
50-0150-054	65-67	41-5495SH	7	63-2840SH	31	76-9-407SH	26
50-0150-056	65-67	41-6470SH	7	63-2851SH	31	76-9-834SH	26
50-0150-059	65-67	41-6475SH	7	63-2863SH	31	80-1035	8
50-0150-134	65-67	63-0103SH	31	63-2875SH	31	80-1040	8
50-0200-052	65-67	63-0106SH	31	63-2893SH	31	80-1045	8
50-0200-053	65-67	63-0107SH	31	63-29118SH	31	80-1050	8
50-0200-054	65-67	63-0403SH	31	63-2911SH	31	80-1055	5
50-0200-056	65-67	63-0406SH	31	63-29145SH	31	80-2035	5

Alphanumeric Page Reference

80-2040	6	85-6060SH	7	ES-10200.326	59	FP12-604	73
80-3035	6	85-6065SH	7	ES-10200.366	59	FP12-651	73
80-3040	6	85-LM020	48	ES-10200.376	59	FP12-652	73
80-4035	6	85-LM025	48	ES-10200.386	59	FP12-653	73
80-4040	6	85-LM030	48	ES-10210.326	59	FP12-654	73
80-5035	9	85-LM035	48	ES-10210.366	59	GLF 114	72
80-5040	9	85-LM040	48	ES-10210.376	59	HC-0050-41	61-64
80-6035	9	85-LM045	48	ES-10210.386	59	HC-0050-4100	61-64
80-6040	10	85-LM050	48	ES-10230.326	59	HC-0050-44	61-64
80-7235	10	85-LM055	48	ES-10230.366	59	HC-0050-4400	61-64
80-7240	10	85-M020	48	ES-10230.376	59	HC-0050-46	61-64
80-7245	10	85-M025	48	ES-10230.386	59	HC-0050-47	61-64
80-7250	10	85-M030	48	ES-10250.326	59	HC-0075-41	61-64
80-7255	10	85-M035	48	ES-10250.376	59	HC-0075-4100	61-64
84-10000-3PTT	34	85-M040	48	ES-10250.386	59	HC-0075-44	61-64
84-1000-3PTT	34	85-M045	48	ES-10300.326	59	HC-0075-4400	61-64
84-1120-ODY	35	85-M050	48	ES-10300.376	59	HC-0075-46	61-64
84-1500-3PTT	34	85-M055	48	ES-10300.386	59	HC-0075-47	61-64
84-1690-ODY	35	85-Y020	48	ES-11130.326	15	HC-0100-41	61-64
84-2250-ODY	35	85-Y025	48	ES-11130.359	15	HC-0100-4100	61-64
84-2500-3PTT	34	85-Y030	48	ES-11170.326	15	HC-0100-44	61-64
84-3300-ODY	35	85-Y035	48	ES-11170.359	15	HC-0100-4400	61-64
84-3750-3PTT	34	85-Y040	48	ES-11190.326	15	HC-0100-46	61-64
84-5000-3PTT	34	85-Y045	48	ES-11190.359	15	HC-0100-47	61-64
84-500-3PTT	34	85-Y050	48	ES-11200.326	15	HC-0150-41	61-64
84-5600-ODY	35	85-Y055	48	ES-11200.359	15	HC-0150-4100	61-64
84-7500-3PTT	34	AP12-351	72	ES-11210.326	15	HC-0150-44	61-64
85-1020SH	5	AP12-352	72	ES-11210.359	15	HC-0150-4400	61-64
85-1025SH	5	AP12-353	72	ES-11230.326	15	HC-0150-46	61-64
85-1030SH	5	AP12-354	72	ES-11230.359	15	HC-0150-47	61-64
85-1035SH	5	AP12-401	72	ES-11250.326	15	HC-0250-41	61-64
85-1040SH	5	AP12-402	72	ES-11250.359	15	HC-0250-4100	61-64
85-1045SH	5	AP12-403	72	ES-11300.326	15	HC-0250-44	61-64
85-1050SH	5	AP12-404	72	ES-11300.359	15	HC-0250-4400	61-64
85-1055SH	5	AP12-451	72	ES-11330.326	15	HC-0250-46	61-64
85-1060SH	5	AP12-452	72	ES-11330.359	15	HC-0250-47	61-64
85-1065SH	5	AP12-453	72	ES-11360.326	15	HC-0250-47	61-64
85-1070SH	5	AP12-454	72	ES-11360.359	15	HC-0375-41	61-64
85-1075SH	5	AP12-501	72	ES-11380.326	15	HC-0375-4100	61-64
85-1450SH	5	AP12-502	72	ES-11380.359	15	HC-0375-44	61-64
85-1455SH	5	AP12-503	72	ES-11410.326	15	HC-0375-46	61-64
85-1460SH	5	AP12-504	72	ES-11410.359	15	HC-0375-47	61-64
85-1465SH	5	AP12-551	72	ES-31200.542	30	HC-0500-41	61-64
85-1470SH	5	AP12-552	72	ES-31200.552	30	HC-0500-4100	61-64
85-1475SH	5	AP12-553	72	ES-31250.542	30	HC-0500-44	61-64
85-3020SH	6	AP12-554	72	ES-31250.552	30	HC-0500-4400	61-64
85-3025SH	6	AP12-601	72	ES-31310.542	30	HC-0500-46	61-64
85-3030SH	6	AP12-602	72	ES-31310.552	30	HC-0500-47	61-64
85-3035SH	6	AP12-603	72	ES-31360.542	30	HC-0750-41	61-64
85-3040SH	6	AP12-604	72	ES-31360.552	30	HC-0750-4100	61-64
85-3045SH	6	AP12-651	72	ES-31380.542	30	HC-0750-44	61-64
85-3050SH	6	AP12-652	72	ES-31380.552	30	HC-0750-4400	61-64
85-3055SH	6	AP12-653	72	ES-31390.542	30	HC-0750-46	61-64
85-3060SH	6	AP12-654	72	ES-31390.552	30	HC-0750-47	61-64
85-3065SH	6	BR-734-1	69	ES-31410.542	30	HC-1000-41	61-64
85-4020SH	6	BR-734-2	69	ES-31410.552	30	HC-1000-4100	61-64
85-4025SH	6	BR-734-3	69	ES-31420.542	30	HC-1000-44	61-64
85-4030SH	6	BR-734-4	69	ES-31420.552	30	HC-1000-4400	61-64
85-4035SH	6	BR-734-5	69	ES-31450.542	30	HC-1000-46	61-64
85-4040SH	6	BR-734-6	69	ES-31450.552	30	HC-1000-47	61-64
85-4045SH	6	BR-734-7	69	FKP2	64	HC-1500-41	61-64
85-4050SH	6	BR-734-8	69	FKS	64	HC-1500-4100	61-64
85-4055SH	6	BR-734-9	69	FP12-351	73	HC-1500-44	61-64
85-4060SH	6	BR-890	69	FP12-352	73	HC-1500-4400	61-64
85-4065SH	6	BR-892	69	FP12-353	73	HC-1500-46	61-64
85-5020SH	7	ES-10100.326	58-60	FP12-354	73	HC-1500-47	61-64
85-5025SH	7	ES-10100.366	58-60	FP12-401	73	HC-2000-41	61-64
85-5030SH	7	ES-10100.376	58-60	FP12-402	73	HC-2000-4100	61-64
85-5035SH	7	ES-10100.386	58-60	FP12-403	73	HC-2000-44	61-64
85-5040SH	7	ES-10130.326	58-60	FP12-404	73	HC-2000-4400	61-64
85-5045SH	7	ES-10130.366	58-60	FP12-451	73	HC-2000-46	61-64
85-5050SH	7	ES-10130.376	58-60	FP12-452	73	HC-2000-47	61-64
85-5055SH	7	ES-10130.386	58-60	FP12-453	73	HL12-1025SH	18
85-5060SH	7	ES-10150.326	58-60	FP12-454	73	HL12-1030SH	18
85-5065SH	7	ES-10150.366	58-60	FP12-501	73	HL12-1035SH	18
85-5470SH	7	ES-10150.376	58-60	FP12-502	73	HL12-1040SH	18
85-5475SH	7	ES-10150.386	58-60	FP12-503	73	HL12-1045SH	18
85-6020SH	7	ES-10170.326	58-60	FP12-504	73	HL12-1050SH	18
85-6025SH	7	ES-10170.366	58-60	FP12-551	73	HL12-1055SH	18
85-6030SH	7	ES-10170.376	58-60	FP12-552	73	HL12-1060SH	18
85-6035SH	7	ES-10170.386	58-60	FP12-553	73	HL12-1065SH	18
85-6040SH	7	ES-10190.326	58-60	FP12-554	73	HL12-1070SH	18
85-6045SH	7	ES-10190.366	58-60	FP12-601	73	HL12-1075SH	18
85-6050SH	7	ES-10190.376	58-60	FP12-602	73	HL12-5025SH	18
85-6055SH	7	ES-10190.386	58-60	FP12-603	73	HL12-5030SH	18

Alphanumeric Page Reference

HL12-5035SH.....	18	63-75-834SH.....	25	IC-0750-109.....	52	ADLK-200.....	80
HL12-5040SH.....	18	63-112-834SH.....	25	IC-1000-109.....	52	ADLK-210.....	80
HL12-5045SH.....	18	63-150-834SH.....	25	IC-1500-109.....	52	ADLK-230.....	80
HL12-5050SH.....	18	76-3-407SH.....	26	IC-2000-109.....	52	ADLK-250.....	80
HL12-5055SH.....	18	76-6-407SH.....	26	IC-3000-109.....	52	ADLK12-130.....	81
HL12-5060SH.....	18	76-9-407SH.....	26	IC-0050-110.....	53	ADLK12-170.....	81
HL12-5065SH.....	18	63-15-407SH.....	26	IC-0075-110.....	53	ADLK12-190.....	81
HL12-5070SH.....	18	63-30-407SH.....	26	IC-0100-110.....	53	ADLK12-200.....	81
HL12-5075SH.....	18	63-45-407SH.....	26	IC-0150-110.....	53	ADLK12-210.....	81
85-8020SH.....	9	63-75-407SH.....	26	IC-0250-110.....	53	ADLK12-230.....	81
85-8025SH.....	9	63-112-407SH.....	26	IC-0350-110.....	53	ADLK12-250.....	81
85-8030SH.....	9	63-150-407SH.....	26	IC-0500-110.....	53	TDG12-300.....	82
85-8035SH.....	9	76-3-3117SH.....	26	IC-0050-122.....	53	TDG12-330.....	82
85-8040SH.....	9	76-6-3117SH.....	26	IC-0075-122.....	53	TMAK-130.....	83
85-8045SH.....	9	76-9-3117SH.....	26	IC-0100-122.....	53	TMAK-170.....	83
85-8050SH.....	9	63-15-3117SH.....	26	IC-0150-122.....	53	TMAK-190.....	83
85-8055SH.....	9	63-30-3117SH.....	26	IC-0250-122.....	53	TMAK-200.....	83
85-8060SH.....	9	63-45-3117SH.....	26	IC-0350-122.....	53	TMBK-130.....	83
85-8065SH.....	9	63-75-3117SH.....	26	IC-0500-122.....	53	TMBK-170.....	83
85-8070SH.....	9	63-112-3117SH.....	26	IC-0750-122.....	53	TMBK-190.....	83
FP4X-1030SH.....	10	63-150-3117SH.....	26	IC-1000-122.....	53	TMBK-200.....	83
FP4X-1035SH.....	10	84-1500-4173E.....	26	IC-0050-123.....	54	TMCK-130.....	83
FP4X-1040SH.....	10	84-3000-4173E.....	26	IC-0075-123.....	54	TMCK-170.....	83
FP4X-1045SH.....	10	84-4500-4173E.....	26	IC-0100-123.....	54	TMCK-190.....	83
FP4X-1050SH.....	10	64-7500-4173.....	26	IC-0150-123.....	54	TMCK-200.....	83
FP4X-1055SH.....	10	64-11250-4173.....	26	IC-0250-123.....	54		
FP4X-1060SH.....	10	64-15000-4173.....	26	IC-0350-123.....	54		
FP4X-1065SH.....	10	64-22500-4173.....	26	IC-0500-123.....	54		
FP4X-1070SH.....	10	64-30000-4173.....	26	IC-0750-123.....	54		
85-1-2915SH.....	10	64-37500-4173.....	26	IC-1000-123.....	54		
85-1.5-2915SH.....	10	64-50000-4173.....	26	IC-1500-123.....	54		
85-2-2915SH.....	10	IC-0050-102.....	51	IC-2000-123.....	54		
85-3-2915SH.....	10	IC-0075-102.....	51	IC-3000-123.....	54		
85-5-2915SH.....	10	IC-0100-102.....	51	IC-0050-127.....	55		
85-7.5-2915SH.....	10	IC-0150-102.....	51	IC-0075-127.....	55		
85-10-2915SH.....	10	IC-0250-102.....	51	IC-0100-127.....	55		
85-15-2915SH.....	10	IC-0350-102.....	51	IC-0150-127.....	55		
ES-13200.406.....	11	IC-0500-102.....	51	IC-0250-127.....	55		
ES-13230.406.....	11	IC-0750-102.....	51	IC-0350-127.....	55		
ES-13250.406.....	11	IC-1000-102.....	51	IC-0500-127.....	55		
ES-13300.406.....	11	IC-0050-103.....	51	IC-0750-127.....	55		
ES-13330.406.....	11	IC-0075-103.....	51	IC-1000-127.....	55		
ES-13360.406.....	11	IC-0100-103.....	51	IC-1500-127.....	55		
ES-13380.406.....	11	IC-0150-103.....	51	IC-2000-127.....	55		
ES-13410.406.....	11	IC-0250-103.....	51	IC-3000-127.....	55		
ES-13200.344.....	11	IC-0350-103.....	51	IC-0050-129.....	55		
ES-13230.344.....	11	IC-0500-103.....	51	IC-0075-129.....	55		
ES-13250.344.....	11	IC-0750-103.....	51	IC-0100-129.....	55		
ES-13300.344.....	11	IC-1000-103.....	51	IC-0150-129.....	55		
ES-13330.4344.....	11	IC-1500-103.....	51	IC-0250-129.....	55		
ES-13360.344.....	11	IC-2000-103.....	51	IC-0350-129.....	55		
ES-13380.344.....	11	IC-3000-103.....	51	IC-0500-129.....	55		
ES-13410.344.....	11	IC-0050-104.....	51	IC-0750-129.....	55		
ES-13200.498.....	11	IC-0075-104.....	51	IC-1000-129.....	55		
ES-13230.498.....	11	IC-0100-104.....	51	TDLK-130.....	76		
ES-13250.498.....	11	IC-0150-104.....	51	TDLK-170.....	76		
ES-13300.498.....	11	IC-0250-104.....	51	TDLK-190.....	76		
ES-13330.498.....	11	IC-0350-104.....	51	TDLK-200.....	76		
ES-13360.498.....	11	IC-0500-104.....	51	TDLK-210.....	76		
ES-13380.498.....	11	IC-0050-106.....	52	TDLK-230.....	76		
ES-13410.498.....	11	IC-0075-106.....	52	TDLK-250.....	76		
76-6-2601SH.....	25	IC-0100-106.....	52	TDLK12-130.....	77		
76-6-2601SH.....	25	IC-0150-106.....	52	TDLK12-170.....	77		
76-9-2601SH.....	25	IC-0250-106.....	52	TDLK12-190.....	77		
73-15-3494SH.....	25	IC-0350-106.....	52	TDLK12-200.....	77		
73-30-3494SH.....	25	IC-0500-106.....	52	TDLK12-210.....	77		
73-45-3494SH.....	25	IC-0050-107.....	52	TDLK12-230.....	77		
73-75-3494SH.....	25	IC-0075-107.....	52	TDLK12-250.....	77		
73-112-3494SH.....	25	IC-0100-107.....	52	TDEK-130.....	78		
73-150-3494SH.....	25	IC-0150-107.....	52	TDEK-170.....	78		
76-3-3723SH.....	25	IC-0250-107.....	52	TDEK-190.....	78		
76-6-3723SH.....	25	IC-0350-107.....	52	TDEK-200.....	78		
76-9-3723SH.....	25	IC-0500-107.....	52	TDEK-210.....	78		
73-15-3943SH.....	25	IC-0750-107.....	52	TDEK-230.....	78		
73-30-3943SH.....	25	IC-1000-107.....	52	TDEK-250.....	78		
73-45-3943SH.....	25	IC-1500-107.....	52	TDEK12-130.....	79		
73-75-3943SH.....	25	IC-2000-107.....	52	TDEK12-170.....	79		
73-112-3943SH.....	25	IC-3000-107.....	52	TDEK12-190.....	79		
73-150-3943SH.....	25	IC-0050-109.....	52	TDEK12-200.....	79		
76-3-834SH.....	25	IC-0075-109.....	52	TDEK12-210.....	79		
76-6-834SH.....	25	IC-0100-109.....	52	TDEK12-230.....	79		
76-9-834SH.....	25	IC-0150-109.....	52	TDEK12-250.....	79		
63-15-834SH.....	25	IC-0250-109.....	52	ADLK-130.....	80		
63-30-834SH.....	25	IC-0350-109.....	52	ADLK-170.....	80		
63-45-834SH.....	25	IC-0500-109.....	52	ADLK-190.....	80		

Dongan Electric Manufacturing Company

34760 Garfield Road
Fraser, MI, 48026-1804 USA

800.428.2626 • 313.567.8500
Fax: 586.296.2553

www.dongan.com • sales@dongan.com

Pioneer Transformer Company
A Wholly Owned Subsidiary
500 Cedar Street
Pioneer, OH 43554 USA



Products Engineered with quality for over 100 years